



**STRONGER  
THAN STEEL.™**

**DRYWALL FRAMING SYSTEM**

IN CONFORMANCE WITH: IBC 2021 • AISI S100 • AISI S220

ProSTUD® DRYWALL  
FRAMING SYSTEM

ClarkDietrich.

WHERE INNOVATION  
TAKES FORM.

## The ProSTUD® Drywall Framing System with Smart Edge™

**Technology** can be called many things. Strong. Versatile. Fast. And without a doubt—revolutionary. But one of the biggest benefits to keep in mind is this: ProSTUD was developed, tested and approved by pros in the field who demanded nothing less than achieving absolute ease of use. Its performance has also been proven by the most extensive laboratory evaluations available. All of which means ProSTUD comes with complete confidence and no questions about code compliance. With the backing of online, mobile and data-rich BIM resources, there's no better example of a broader vision at work.

ProSTUD, in fact, is just one example of how ClarkDietrich can reinforce your efforts to design and build more intelligently. Yes, we're known as a manufacturer of extensively tested, code-compliant steel framing products, but we offer so much more. Our products perform as a system. We support a range of efforts for smarter installation and design.

We provide the expertise of a versatile engineering services team. And we do it all on a nationwide scale.

We've put together an incredible array of resources to help you be successful on any project, regardless of size or complexity. Within this catalog you'll discover the multiple advantages ProSTUD has to offer, as well as detailed information on the product lineup, limiting heights, sound and fire assemblies, and more.

Ultimately, your choice of ProSTUD doesn't come down to the integrity of the product alone, or even its ease of use. You're also looking to the strength of the company that stands behind it. Count on the expertise, services and full support of ClarkDietrich today—and far into the future.

### Need Product Submittals?

Use **SubmittalPro®** at [clarkdietrich.com](http://clarkdietrich.com).

## TABLE OF CONTENTS

### ProSTUD Drywall Framing System

Table of Contents	3
Overview	4
Profile Information	5

### Physical & Structural Properties

ProSTUD 25 (15mil)	6
ProSTUD 20 (18 mil)	7
ProSTUD 30MIL	8
ProSTUD 33MIL	9

### Limiting Heights Overview 10-11

### Head-of-Wall (HOW) Composite

ProSTUD 25 (15mil) w/MaxTRAK®	12
ProSTUD 20 (18 mil) w/MaxTRAK®	13
ProSTUD 25 (15mil) w/Deflection Track	14
ProSTUD 20 (18 mil) w/Deflection Track	15

### Full Composite Limiting Heights Tables 16-17

### Non-Composite Limiting Heights Tables

Fully Braced	18
Braced at 48" o.c.	19

### Sound Testing

Sound Assemblies	20-21
------------------	-------

### Fire Testing

UL® Listed Wall Assemblies	22
----------------------------	----

### Connections

Deflection Track Systems	23
--------------------------	----

### Ceiling Span Tables 24

### Connections

Allowable Screw Design Values	25
-------------------------------	----

### General

Collaborative Services	26
Code Compliance and Certification	27

## What is an Equivalent (EQ) Drywall Stud?

Gauge equivalent drywall framing must meet the minimum performance requirements of conventional drywall framing as defined by the Steel Framing Industry Association (SFIA). The industry’s “EQ” product of choice, ProSTUD<sup>®</sup>, employs roll-forming and steel-making technology, exceeding the performance of conventional drywall framing for allowable moment and screw connection strength. When comparing drywall framing systems, it is important to keep in mind Life Safety, System Performance and Connections. The ProSTUD Drywall Framing System provides peace of mind for all three important functions by providing the right selection of products and product data for every application.

ProSTUD Drywall Framing		Conventional Drywall Framing	
ProSTUD 25	15mil	25 Gauge	18mil
ProSTUD 20	18mil	20 Gauge	30mil

### Life Safety

Life Safety is the primary concern and duty of all construction and design professionals. For interior drywall framing members, bending strength is the criteria most important to the strength of a wall or ceiling. AISI defines bending or flexural strength by Allowable Moment. The corresponding chart compares the bending strength of ProSTUD and conventional drywall studs.

Allowable Bending Capacity, 3-5/8" Stud

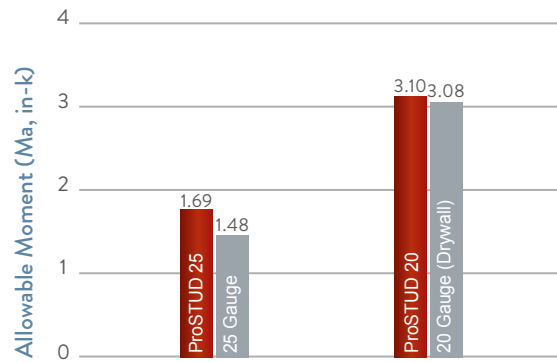

### System Performance

Given ProSTUD’s strength and versatility, it’s important to know the performance of the ProSTUD member under your project’s specific criteria. This catalog will provide guidance in a variety of assemblies and loading criteria, based on current building codes. Additional data is available at [clarkdietrich.com](http://clarkdietrich.com).

### Connections

In addition to sufficient member strength, it’s important to know how connections will perform. Connections can be critical to the capacity and safety of an assembly, but they are also important for the attachment of cabinets, shelving, handrails, and other accessories to steel framing. The tables below compare the screw performance of ProSTUD to conventional drywall framing. This performance relationship to conventional studs can be applied to a variety of fasteners and connections.

#6 Screw Pullout Values

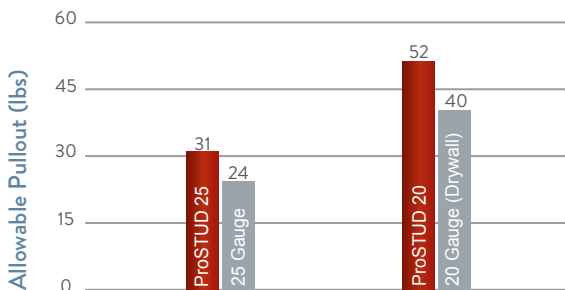

#6 Screw Shear (Bearing) Values

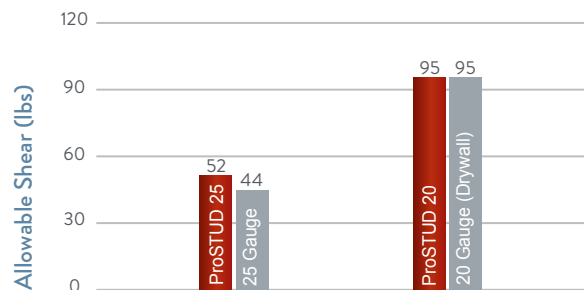

Along with connection capacity, conventional framing members are required to meet performance criteria for screw spinout. ProSTUD was developed with screw performance in mind. High-strength steel, flange stiffening grooves, web embossments, and knurling features combine to provide the best performance per thickness, exceeding the requirements of AISI S220.

### Construction Advantages

- High-strength steel combined with low-profile flange stiffening grooves and double offset web planking increases strength and provides greater limiting heights
- Diamond-embossed web creates stiffness, reducing flange fade and screw spinout during drywall installation
- Strong, lightweight stud and track cuts and handles easier than conventional flat steel studs
- Flange grooves provide sight line for drywall alignment and aid in positioning screws at drywall joints to maintain the 3/8" edge requirement
- Web and leg enhancements in ProTRAK® provide straight and rigid legs, making it the best choice for framing walls, headers, soffits, and bulkheads

### Design Advantages

- Designed to meet the additional strength requirements of today's building codes: IBC 2021, AISI S100, S220, S916 and ICC-ES AC46 and AC86
- Smart Edge™ Technology is an enhancement for producing easier-to-handle steel that reduces the risk of cuts and scrapes
- UL Classified and listed in over 50 designs, including U419, V438, and chase wall assemblies
- Exceptional sound performance in over 30 tested sound assemblies
- Can contribute LEED® points in LEED v4.1 or v4. EPD and HPD verifications also available.
- National availability

### ProSTUD®

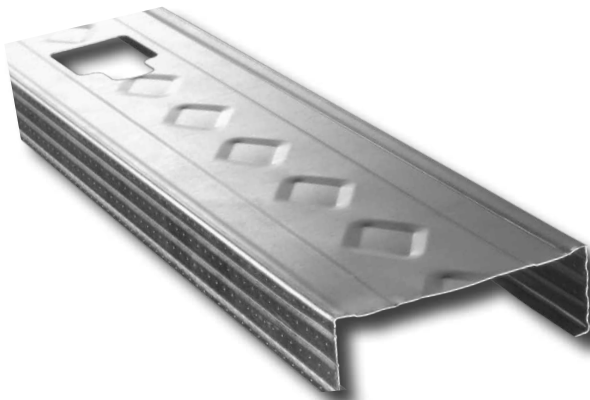

- Web Widths: 1-5/8," 2-1/2," 3-1/2," 3-5/8," 4," 5-1/2," and 6"
- Flange: 1-1/4"
- Return Lip: varies by stud size
- **Material Thicknesses:**  
 ProSTUD 25 / 15mil (25ga EQ) 50ksi  
 ProSTUD 20 / 18mil (20ga EQ) 70ksi  
 ProSTUD 30MIL 33ksi  
 ProSTUD 33MIL 33ksi
- G40EQ is standard, G40 available upon request.
- Other coatings available as special order: G40EQ DiamondPlus®, G60 and G90.
- G40EQ DiamondPlus® is only available in select markets and thicknesses. Contact your local sales representative for market availability.

#### ProSTUD Profile

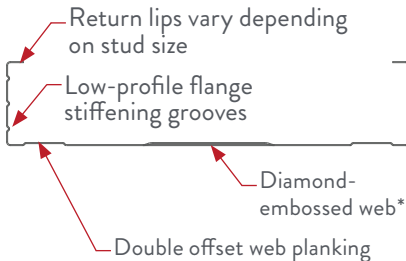

#### Shipping / Stacking



Double offset in web prevents flange locking of studs

#### Drywall Joint

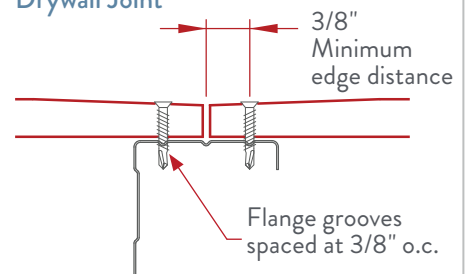

\*Except in 1-5/8"

### ProTRAK



- Web Widths: 1-5/8," 2-1/2," 3-1/2," 3-5/8," 4," 5-1/2," and 6"
- Legs: 1," 1-1/4," 1-1/2," 2," 2-1/2," and 3"  
 \*Not all combinations of web, leg, and gauge are available.
- **Material Thicknesses:**  
 ProTRAK 25 / 15mil (25ga EQ) 50ksi  
 ProTRAK 20 / 18mil (20ga EQ) 50ksi  
 ProTRAK 30MIL 33ksi  
 ProTRAK 33MIL 33ksi
- G40EQ is standard, G40 available upon request.
- Other coatings available as special order: G40EQ DiamondPlus®, G60 and G90.
- G40EQ DiamondPlus® is only available in select markets and thicknesses. Contact your local sales representative for market availability.

Complies with IBC 2021 • AISI S100 • AISI S220

## ProSTUD® 25 (15mil) Drywall Stud

## ClarkDietrich ProSTUD 25 (15mil) physical and structural properties

Member	Design thickness (in)	Fy (ksi)	Gross Section Properties						Effective Section Properties at Fy						Torsional Properties					Lu (in)
			Area (in <sup>2</sup> )	Weight (lb/ft)	Ix (in <sup>4</sup> )	Rx (in)	Iy (in <sup>4</sup> )	Ry (in)	Ae (in <sup>2</sup> )	Ix (in <sup>4</sup> )	Sx (in <sup>3</sup> )	Ma (in-lbs)	Vag (lb)	Vanet (lb)	Jx1000 (in <sup>4</sup> )	Cw (in <sup>6</sup> )	Xo (in)	Ro (in)	β Beta	
162PDS125-15	0.0158	50	0.071	0.24	0.033	0.688	0.015	0.466	0.033	0.030	0.024	719	232	104	0.00589	0.009	-1.088	1.369	0.368	24.8
250PDS125-15	0.0158	50	0.085	0.29	0.088	1.020	0.018	0.459	0.033	0.080	0.044	1198	147	141	0.00704	0.023	-0.959	1.473	0.576	24.5
362PDS125-15 <sup>1</sup>	0.0158	50	0.102	0.35	0.206	1.420	0.020	0.442	0.034	0.190	0.056	1689	100	100	0.00852	0.051	-0.837	1.706	0.760	24.3
400PDS125-15 <sup>1</sup>	0.0158	50	0.108	0.37	0.260	1.549	0.021	0.436	0.034	0.233	0.062	1870	90	90	0.00901	0.064	-0.803	1.798	0.800	24.2
600PDS125-15 <sup>2</sup>	0.0158	50	0.140	0.48	0.683	2.209	0.023	0.404	0.034	0.537	0.105	2781	60	60	0.01164	0.161	-0.666	2.343	0.919	23.6

## ProTRAK® 25 (15mil) Drywall Track

## ClarkDietrich ProTRAK 25 (15mil) physical and structural properties

Member	Design thickness (in)	Fy (ksi)	Gross Section Properties						Effective Section Properties at Fy						Torsional Properties				
			Area (in <sup>2</sup> )	Weight (lb/ft)	Ix (in <sup>4</sup> )	Rx (in)	Iy (in <sup>4</sup> )	Ry (in)	Ae (in <sup>2</sup> )	Ix (in <sup>4</sup> )	Sx (in <sup>3</sup> )	Ma (in-lbs)	Vag (lb)	Jx1000 (in <sup>4</sup> )	Cw (in <sup>6</sup> )	Xo (in)	Ro (in)	β Beta	
162PDT125-15	0.0158	50	0.065	0.22	0.034	0.717	0.011	0.412	0.020	0.021	0.016	464	222	0.00542	0.006	-0.881	1.208	0.468	
250PDT125-15	0.0158	50	0.079	0.27	0.085	1.038	0.013	0.400	0.020	0.059	0.024	724	143	0.00657	0.015	-0.771	1.353	0.675	
362PDT125-15 <sup>1</sup>	0.0158	50	0.097	0.33	0.196	1.425	0.014	0.381	0.021	0.125	0.035	1059	98	0.00805	0.034	-0.668	1.619	0.830	
400PDT125-15 <sup>1</sup>	0.0158	50	0.103	0.35	0.247	1.550	0.014	0.374	0.021	0.153	0.039	1171	89	0.00854	0.043	-0.640	1.718	0.861	
600PDT125-15 <sup>2</sup>	0.0158	50	0.134	0.46	0.646	2.194	0.016	0.343	0.021	0.350	0.059	1762	59	0.01117	0.108	-0.524	2.282	0.947	
162PDT200-15	0.0158	50	0.089	0.30	0.050	0.752	0.039	0.663	0.020	0.025	0.015	455	222	0.00739	0.020	-1.579	1.870	0.287	
250PDT200-15	0.0158	50	0.103	0.35	0.124	1.098	0.045	0.662	0.021	0.064	0.024	720	143	0.00854	0.052	-1.431	1.921	0.445	
362PDT200-15 <sup>1</sup>	0.0158	50	0.120	0.41	0.277	1.516	0.051	0.648	0.021	0.137	0.036	1063	98	0.01002	0.120	-1.282	2.088	0.623	
400PDT200-15 <sup>1</sup>	0.0158	50	0.126	0.43	0.344	1.650	0.052	0.642	0.021	0.168	0.039	1178	89	0.01052	0.151	-1.240	2.162	0.671	
600PDT200-15 <sup>2</sup>	0.0158	50	0.158	0.54	0.864	2.338	0.058	0.608	0.021	0.389	0.060	1789	59	0.01315	0.383	-1.058	2.638	0.839	
162PDT250-15	0.0158	50	0.105	0.36	0.061	0.766	0.071	0.824	0.020	0.027	0.015	455	222	0.00871	0.038	-2.058	2.345	0.230	
250PDT250-15	0.0158	50	0.118	0.40	0.150	1.123	0.082	0.831	0.021	0.066	0.024	725	143	0.00986	0.096	-1.892	2.352	0.353	
362PDT250-15 <sup>1</sup>	0.0158	50	0.136	0.46	0.330	1.557	0.092	0.823	0.021	0.142	0.036	1073	98	0.01134	0.220	-1.720	2.462	0.512	
400PDT250-15 <sup>1</sup>	0.0158	50	0.142	0.48	0.409	1.696	0.095	0.819	0.021	0.174	0.040	1189	89	0.01183	0.275	-1.670	2.517	0.560	
600PDT250-15 <sup>2</sup>	0.0158	50	0.174	0.59	1.009	2.409	0.108	0.787	0.021	0.404	0.060	1809	59	0.01446	0.697	-1.452	2.921	0.753	

## Notes:

- Calculated properties are based on AISI S100-16 (2020) w/S2-20 North American Specification for Design of Cold-Formed Steel Structural Members and AISI S220-20 North American Standard for Cold-Formed Steel Framing—Nonstructural Members.
  - Effective properties incorporate the strength increase from the cold work of forming as applicable per Section A3.3.2 of AISI S100-16 (2020) w/S2-20.
  - Tabulated gross properties, including torsional properties, are based on full-unreduced cross section of the studs, away from punchouts.
  - Tabulated gross properties, including torsional properties, are based on full-unreduced cross section of the tracks.
  - For deflection calculations, use the effective moment of inertia.
  - Allowable moment includes cold work of forming.
  - Allowable moment is taken as the lowest value based on local or distortional buckling. Distortional buckling strength is based on a  $k\text{-}\phi = 0$ .
  - Web depth for track sections is equal to the nominal height plus two times the design thickness plus the bend radius. Hems on nonstructural track sections are ignored.
- 1 Web-height to thickness ratio exceeds 200.
  - 2 Web-height to thickness ratio exceeds 260.

ProSTUD® 20 (18mil) Drywall Stud			ClarkDietrich ProSTUD 20 (18mil) physical and structural properties																		
Member	Design thickness (in)	Fy (ksi)	Gross Section Properties						Effective Section Properties at Fy						Torsional Properties						Lu (in)
			Area (in <sup>2</sup> )	Weight (lb/ft)	Ix (in <sup>4</sup> )	Rx (in)	Iy (in <sup>4</sup> )	Ry (in)	Ae (in <sup>2</sup> )	Ix (in <sup>4</sup> )	Sx (in <sup>3</sup> )	Ma (in-lbs)	Vag (lb)	Vanet (lb)	Jx1000 (in <sup>4</sup> )	Cw (in <sup>6</sup> )	Xo (in)	Ro (in)	β Beta		
162PDS125-18	0.0190	70	0.086	0.29	0.040	0.685	0.019	0.468	0.039	0.035	0.028	1194	405	149	0.01032	0.012	-1.105	1.382	0.361	24.8	
250PDS125-18	0.0190	70	0.104	0.35	0.107	1.017	0.023	0.470	0.043	0.099	0.056	2361	256	204	0.01250	0.031	-1.004	1.504	0.555	24.5	
362PDS125-18	0.0190	70	0.126	0.43	0.254	1.421	0.026	0.456	0.044	0.234	0.074	3102	174	170	0.01512	0.070	-0.884	1.734	0.740	24.3	
400PDS125-18 <sup>1</sup>	0.0190	70	0.133	0.45	0.321	1.551	0.027	0.453	0.046	0.286	0.084	3532	157	157	0.01605	0.089	-0.859	1.830	0.780	24.2	
600PDS125-18 <sup>2</sup>	0.0190	70	0.173	0.59	0.855	2.223	0.032	0.431	0.046	0.669	0.141	5891	104	104	0.02083	0.233	-0.739	2.382	0.904	23.6	

ProTRAK® 20 (18mil) Drywall Track			ClarkDietrich ProTRAK 20 (18mil) physical and structural properties																	
Member	Design thickness (in)	Fy (ksi)	Gross Section Properties						Effective Section Properties at Fy						Torsional Properties					
			Area (in <sup>2</sup> )	Weight (lb/ft)	Ix (in <sup>4</sup> )	Rx (in)	Iy (in <sup>4</sup> )	Ry (in)	Ae (in <sup>2</sup> )	Ix (in <sup>4</sup> )	Sx (in <sup>3</sup> )	Ma (in-lbs)	Vag (lb)	Jx1000 (in <sup>4</sup> )	Cw (in <sup>6</sup> )	Xo (in)	Ro (in)	β Beta		
162PDT125-18	0.0190	50	0.078	0.27	0.040	0.718	0.013	0.411	0.028	0.027	0.022	663	380		0.00943	0.007	-0.879	1.207	0.470	
250PDT125-18	0.0190	50	0.095	0.32	0.102	1.038	0.015	0.400	0.029	0.073	0.034	1029	248		0.01143	0.017	-0.770	1.353	0.676	
362PDT125-18	0.0190	50	0.116	0.40	0.236	1.426	0.017	0.380	0.029	0.173	0.050	1497	170		0.01400	0.041	-0.666	1.619	0.831	
400PDT125-18	0.0190	50	0.123	0.42	0.297	1.550	0.017	0.374	0.029	0.211	0.055	1653	154		0.01486	0.051	-0.638	1.718	0.862	
600PDT125-18 <sup>2</sup>	0.0190	50	0.161	0.55	0.778	2.195	0.019	0.342	0.029	0.469	0.083	2473	102		0.01943	0.130	-0.523	2.282	0.947	
162PDT200-18	0.0190	50	0.107	0.36	0.061	0.753	0.047	0.662	0.028	0.032	0.021	642	380		0.01285	0.024	-1.577	1.869	0.288	
250PDT200-18	0.0190	50	0.123	0.42	0.149	1.099	0.054	0.661	0.029	0.088	0.034	1016	248		0.01486	0.063	-1.429	1.920	0.446	
362PDT200-18	0.0190	50	0.145	0.49	0.333	1.517	0.061	0.648	0.029	0.188	0.050	1500	170		0.01743	0.145	-1.280	2.088	0.624	
400PDT200-18	0.0190	50	0.152	0.52	0.414	1.651	0.063	0.642	0.029	0.230	0.055	1661	154		0.01828	0.181	-1.238	2.161	0.672	
600PDT200-18 <sup>2</sup>	0.0190	50	0.190	0.65	1.039	2.339	0.070	0.607	0.030	0.532	0.084	2525	102		0.02286	0.461	-1.057	2.637	0.840	
162PDT250-18	0.0190	50	0.126	0.43	0.074	0.767	0.085	0.823	0.028	0.035	0.021	635	380		0.01514	0.045	-2.056	2.344	0.231	
250PDT250-18	0.0190	50	0.142	0.48	0.180	1.125	0.098	0.830	0.029	0.091	0.034	1011	248		0.01714	0.115	-1.891	2.351	0.353	
362PDT250-18	0.0190	50	0.164	0.56	0.398	1.558	0.111	0.823	0.029	0.195	0.050	1498	170		0.01971	0.264	-1.718	2.461	0.512	
400PDT250-18	0.0190	50	0.171	0.58	0.492	1.697	0.114	0.818	0.029	0.239	0.055	1661	154		0.02057	0.331	-1.669	2.517	0.560	
600PDT250-18 <sup>2</sup>	0.0190	50	0.209	0.71	1.214	2.410	0.129	0.786	0.030	0.555	0.085	2533	102		0.02514	0.838	-1.450	2.920	0.753	

**Notes:**

- Calculated properties are based on AISI S100-16 (2020) w/S2-20 North American Specification for Design of Cold-Formed Steel Structural Members and AISI S220-20 North American Standard for Cold-Formed Steel Framing—Nonstructural Members.
  - Effective properties incorporate the strength increase from the cold work of forming as applicable per Section A3.3.2 of AISI S100-16 (2020) w/S2-20.
  - Tabulated gross properties, including torsional properties, are based on full-unreduced cross section of the studs, away from punchouts.
  - Tabulated gross properties, including torsional properties, are based on full-unreduced cross section of the tracks.
  - For deflection calculations, use the effective moment of inertia.
  - Allowable moment includes cold work of forming.
  - Allowable moment is taken as the lowest value based on local or distortional buckling. Distortional buckling strength is based on a k-phi = 0.
  - Web depth for track sections is equal to the nominal height plus two times the design thickness plus the bend radius. Hems on nonstructural track sections are ignored.
- 1 Web-height to thickness ratio exceeds 200.
  - 2 Web-height to thickness ratio exceeds 260.

**ProSTUD® 30 mil Drywall Stud**  
(AVAILABLE IN SELECT MARKETS)

**ClarkDietrich ProSTUD 30MIL physical and structural properties**

Member	Design thickness (in)	Fy (ksi)	Gross Section Properties						Effective Section Properties at Fy						Torsional Properties					Lu (in)
			Area (in <sup>2</sup> )	Weight (lb/ft)	Ix (in <sup>4</sup> )	Rx (in)	Iy (in <sup>4</sup> )	Ry (in)	Ae (in <sup>2</sup> )	Ix (in <sup>4</sup> )	Sx (in <sup>3</sup> )	Ma (in-lbs)	Vag (lb)	Vanet (lb)	J* 1000 (in <sup>4</sup> )	Cw (in <sup>6</sup> )	Xo (in)	Ro (in)	β Beta	
162PDS125-30	0.0312	33	0.137	0.47	0.064	0.681	0.029	0.458	0.098	0.064	0.067	1332	572	124	0.04459	0.017	-1.070	1.348	0.371	30.8
250PDS125-30	0.0312	33	0.165	0.56	0.169	1.012	0.034	0.451	0.106	0.168	0.121	2356	832	397	0.05345	0.042	-0.941	1.454	0.581	30.1
362PDS125-30	0.0312	33	0.200	0.68	0.398	1.411	0.038	0.434	0.107	0.396	0.170	3358	776	457	0.06484	0.096	-0.820	1.689	0.764	29.7
400PDS125-30	0.0312	33	0.212	0.72	0.501	1.540	0.039	0.428	0.108	0.499	0.189	3737	701	490	0.06864	0.120	-0.787	1.781	0.805	29.5
600PDS125-30	0.0312	33	0.274	0.93	1.324	2.199	0.043	0.396	0.109	1.281	0.338	6031	461	461	0.08888	0.303	-0.651	2.327	0.922	28.7

**ProTRAK® 30 mil Drywall Track**

**ClarkDietrich ProTRAK 30MIL physical and structural properties**

Member	Design thickness (in)	Fy (ksi)	Gross Section Properties						Effective Section Properties at Fy						Torsional Properties				
			Area (in <sup>2</sup> )	Weight (lb/ft)	Ix (in <sup>4</sup> )	Rx (in)	Iy (in <sup>4</sup> )	Ry (in)	Ae (in <sup>2</sup> )	Ix (in <sup>4</sup> )	Sx (in <sup>3</sup> )	Ma (in-lbs)	Vag (lb)	J* 1000 (in <sup>4</sup> )	Cw (in <sup>6</sup> )	Xo (in)	Ro (in)	β Beta	
162PDT125-30	0.0312	33	0.128	0.44	0.067	0.722	0.022	0.409	0.080	0.054	0.048	951	610	0.04168	0.011	-0.872	1.204	0.475	
250PDT125-30	0.0312	33	0.156	0.53	0.169	1.042	0.025	0.397	0.084	0.140	0.087	1713	832	0.05054	0.029	-0.763	1.351	0.681	
362PDT125-30	0.0312	33	0.191	0.65	0.389	1.428	0.027	0.378	0.087	0.330	0.149	2938	755	0.06193	0.067	-0.661	1.619	0.833	
400PDT125-30	0.0312	33	0.203	0.69	0.489	1.553	0.028	0.371	0.088	0.417	0.172	3407	683	0.06573	0.084	-0.633	1.718	0.864	
600PDT125-30	0.0312	33	0.265	0.90	1.278	2.196	0.031	0.340	0.090	1.074	0.240	4737	454	0.08597	0.212	-0.519	2.282	0.948	
162PDT200-30	0.0312	33	0.175	0.60	0.101	0.758	0.076	0.660	0.081	0.067	0.052	1028	610	0.05687	0.040	-1.570	1.864	0.291	
250PDT200-30	0.0312	33	0.203	0.69	0.246	1.103	0.088	0.659	0.086	0.170	0.094	1862	832	0.06573	0.103	-1.423	1.917	0.449	
362PDT200-30	0.0312	33	0.238	0.81	0.549	1.520	0.099	0.645	0.089	0.397	0.160	3159	755	0.07712	0.237	-1.274	2.086	0.627	
400PDT200-30	0.0312	33	0.249	0.85	0.682	1.654	0.102	0.639	0.089	0.502	0.176	3480	683	0.08091	0.297	-1.232	2.160	0.674	
600PDT200-30	0.0312	33	0.312	1.06	1.710	2.342	0.114	0.605	0.091	1.353	0.262	5170	454	0.10116	0.754	-1.051	2.637	0.841	
162PDT250-30	0.0312	33	0.206	0.70	0.123	0.772	0.139	0.821	0.082	0.073	0.054	1059	610	0.06699	0.075	-2.048	2.338	0.233	
250PDT250-30	0.0312	33	0.234	0.80	0.298	1.129	0.160	0.828	0.086	0.186	0.097	1926	832	0.07585	0.190	-1.883	2.347	0.356	
362PDT250-30	0.0312	33	0.269	0.92	0.656	1.562	0.181	0.820	0.089	0.436	0.157	3097	755	0.08724	0.435	-1.712	2.458	0.515	
400PDT250-30	0.0312	33	0.281	0.96	0.812	1.701	0.187	0.816	0.090	0.551	0.173	3425	683	0.09104	0.543	-1.662	2.514	0.563	
600PDT250-30	0.0312	33	0.343	1.17	1.997	2.413	0.211	0.784	0.092	1.473	0.261	5162	454	0.11128	1.373	-1.444	2.919	0.755	

**Notes:**

- Calculated properties are based on AISI S100-16 (2020) w/S2-20 North American Specification for Design of Cold-Formed Steel Structural Members and AISI S220-20 North American Standard for Cold-Formed Steel Framing—Nonstructural Members.
  - Effective properties incorporate the strength increase from the cold work of forming as applicable per Section A3.3.2 of AISI S100-16 (2020) w/S2-20.
  - Tabulated gross properties, including torsional properties, are based on full-unreduced cross section of the studs, away from punchouts.
  - Tabulated gross properties, including torsional properties, are based on full-unreduced cross section of the tracks.
  - For deflection calculations, use the effective moment of inertia.
  - Allowable moment includes cold work of forming.
  - Allowable moment is taken as the lowest value based on local or distortional buckling. Distortional buckling strength is based on a k-phi = 0.
  - Web depth for track sections is equal to the nominal height plus two times the design thickness plus the bend radius. Hems on nonstructural track sections are ignored.
- 1 Web-height to thickness ratio exceeds 200.
- 2 Web-height to thickness ratio exceeds 260.



ProSTUD® 33mil Drywall Stud (AVAILABLE IN SELECT MARKETS)			ClarkDietrich ProSTUD 33MIL physical and structural properties																	
Member	Design thickness (in)	F <sub>y</sub> (ksi)	Gross Section Properties						Effective Section Properties at F <sub>y</sub>						Torsional Properties					Lu (in)
			Area (in <sup>2</sup> )	Weight (lb/ft)	I <sub>x</sub> (in <sup>4</sup> )	R <sub>x</sub> (in)	I <sub>y</sub> (in <sup>4</sup> )	R <sub>y</sub> (in)	A <sub>e</sub> (in <sup>2</sup> )	I <sub>x</sub> (in <sup>4</sup> )	S <sub>x</sub> (in <sup>3</sup> )	Ma (in-lbs)	V <sub>ag</sub> (lb)	V <sub>anet</sub> (lb)	J* 1000 (in <sup>4</sup> )	C <sub>w</sub> (in <sup>6</sup> )	X <sub>o</sub> (in)	R <sub>o</sub> (in)	β Beta	
162PDS125-33	0.0346	33	0.152	0.52	0.070	0.679	0.032	0.456	0.114	0.070	0.078	1541	632	123	0.06059	0.019	-1.065	1.344	0.371	30.8
250PDS125-33	0.0346	33	0.182	0.62	0.186	1.010	0.037	0.449	0.125	0.186	0.138	2697	1007	431	0.07267	0.046	-0.937	1.449	0.582	30.1
362PDS125-33	0.0346	33	0.221	0.75	0.439	1.409	0.041	0.433	0.127	0.439	0.200	3943	1024	541	0.08820	0.106	-0.816	1.685	0.766	29.6
400PDS125-33	0.0346	33	0.234	0.80	0.553	1.538	0.043	0.426	0.128	0.553	0.222	4394	957	602	0.09338	0.132	-0.783	1.777	0.806	29.5
600PDS125-33	0.0346	33	0.303	1.03	1.463	2.196	0.047	0.394	0.130	1.428	0.399	7021	630	630	0.12100	0.332	-0.647	2.323	0.922	28.6

ProTRAK® 33mil Drywall Track			ClarkDietrich ProTRAK 33MIL physical and structural properties																	
Member	Design thickness (in)	F <sub>y</sub> (ksi)	Gross Section Properties						Effective Section Properties at F <sub>y</sub>						Torsional Properties					β Beta
			Area (in <sup>2</sup> )	Weight (lb/ft)	I <sub>x</sub> (in <sup>4</sup> )	R <sub>x</sub> (in)	I <sub>y</sub> (in <sup>4</sup> )	R <sub>y</sub> (in)	A <sub>e</sub> (in <sup>2</sup> )	I <sub>x</sub> (in <sup>4</sup> )	S <sub>x</sub> (in <sup>3</sup> )	Ma (in-lbs)	V <sub>ag</sub> (lb)	J* 1000 (in <sup>4</sup> )	C <sub>w</sub> (in <sup>6</sup> )	X <sub>o</sub> (in)	R <sub>o</sub> (in)			
162PDT125-33	0.0346	33	0.142	0.48	0.075	0.723	0.024	0.409	0.095	0.063	0.056	1104	677		0.05683	0.012	-0.870	1.203	0.477	
250PDT125-33	0.0346	33	0.173	0.59	0.188	1.043	0.027	0.397	0.102	0.160	0.100	1972	1024		0.06891	0.032	-0.762	1.351	0.682	
362PDT125-33	0.0346	33	0.212	0.72	0.432	1.429	0.030	0.377	0.105	0.375	0.170	3358	1024		0.08444	0.074	-0.659	1.618	0.834	
400PDT125-33	0.0346	33	0.225	0.77	0.542	1.554	0.031	0.371	0.106	0.473	0.197	3887	931		0.08962	0.093	-0.632	1.718	0.865	
600PDT125-33	0.0346	33	0.294	1.00	1.418	2.197	0.034	0.339	0.109	1.237	0.287	5681	619		0.11723	0.234	-0.517	2.282	0.949	
162PDT200-33	0.0346	33	0.194	0.66	0.112	0.759	0.085	0.660	0.097	0.077	0.061	1198	677		0.07754	0.045	-1.568	1.862	0.292	
250PDT200-33	0.0346	33	0.225	0.77	0.274	1.104	0.097	0.658	0.104	0.196	0.109	2150	1024		0.08962	0.114	-1.421	1.916	0.450	
362PDT200-33	0.0346	33	0.264	0.90	0.610	1.521	0.110	0.645	0.107	0.452	0.186	3669	1024		0.10515	0.263	-1.272	2.085	0.628	
400PDT200-33	0.0346	33	0.276	0.94	0.758	1.655	0.113	0.639	0.108	0.567	0.215	4246	931		0.11033	0.329	-1.230	2.159	0.675	
600PDT200-33	0.0346	33	0.346	1.18	1.897	2.342	0.126	0.604	0.111	1.520	0.322	6355	619		0.13795	0.835	-1.050	2.637	0.842	
162PDT250-33	0.0346	33	0.229	0.78	0.137	0.774	0.154	0.821	0.098	0.085	0.063	1235	677		0.09135	0.083	-2.046	2.336	0.233	
250PDT250-33	0.0346	33	0.259	0.88	0.331	1.130	0.177	0.827	0.104	0.214	0.113	2225	1024		0.10343	0.211	-1.881	2.346	0.357	
362PDT250-33	0.0346	33	0.298	1.01	0.728	1.563	0.200	0.820	0.108	0.493	0.193	3808	1024		0.11896	0.482	-1.710	2.457	0.516	
400PDT250-33	0.0346	33	0.311	1.06	0.901	1.702	0.207	0.815	0.109	0.622	0.214	4221	931		0.12414	0.602	-1.660	2.514	0.564	
600PDT250-33	0.0346	33	0.380	1.29	2.216	2.414	0.233	0.783	0.111	1.657	0.320	6327	619		0.15175	1.522	-1.443	2.919	0.756	

**Notes:**

- Calculated properties are based on AISI S100-16 (2020) w/S2-20 North American Specification for Design of Cold-Formed Steel Structural Members and AISI S220-20 North American Standard for Cold-Formed Steel Framing—Nonstructural Members.
  - Effective properties incorporate the strength increase from the cold work of forming as applicable per Section A3.3.2 of AISI S100-16 (2020) w/S2-20.
  - Tabulated gross properties, including torsional properties, are based on full-unreduced cross section of the studs, away from punchouts.
  - Tabulated gross properties, including torsional properties, are based on full-unreduced cross section of the tracks.
  - For deflection calculations, use the effective moment of inertia.
  - Allowable moment includes cold work of forming.
  - Allowable moment is taken as the lowest value based on local or distortional buckling. Distortional buckling strength is based on a k-phi = 0.
  - Web depth for track sections is equal to the nominal height plus two times the design thickness plus the bend radius. Hems on nonstructural track sections are ignored.
- 1** Web-height to thickness ratio exceeds 200.
- 2** Web-height to thickness ratio exceeds 260.

## Which ProSTUD® Limiting Heights Table Should I Use?

ProSTUD, like any interior drywall stud, may be used in a variety of applications including walls, ceilings, and soffits. While some conditions may require the expertise of a design professional, many assemblies can be selected based on tabulated data. Using the diagrams below, locate the required assembly and follow the instructions for selecting the proper ProSTUD member.

## Head-of-Wall (HOW) Composite Using Deflection Track

### HOW Composite Wall w/ 30mil 2-1/2" Leg MaxTrak® or 30mil 2-1/2" Deep Leg Deflection Track

HOW Composite limiting heights were tested in accordance with AISI S916 and ICC-ES AC86.

The tests were modified from the standards with the tracks fastened to the test fixture such that the wall stiffness included the track deformation.

**It is important to note that a wall designed using limiting heights from HOW composite tables must be constructed consistent with notes listed below the HOW Composite limiting heights tables.**

**Use Head-of-Wall Composite tables if your wall meets these conditions:**

- Maximum deflection gap is 7/8" or less
  - Meets the requirements of the most common 1/2" and 3/4" deflection gap
- For use with the following Deflection Tracks:
  - 30mil 2-1/2" Leg MaxTrak
  - 30mil 2-1/2" Deep Leg Deflection Track
  - Thicker MaxTrak or Deep Leg Deflection Track noted above are allowed but won't increase limiting heights without additional testing
- 5/8" Type X Gypsum board applied full height in the vertical orientation
  - (Leaving a 7/8" max. deflection gap and not having the board attached to the top deflection track is allowed.)

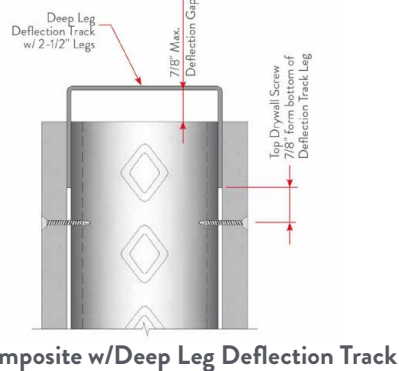
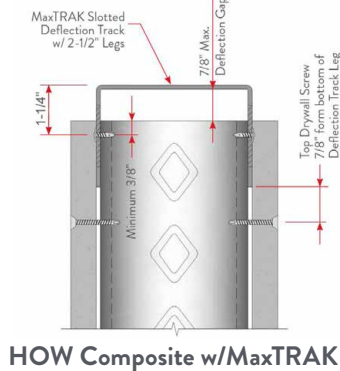

## Full Composite Assemblies

### Full Composite wall w/ 1-1/4" Leg Non-Deflection Track

Full Composite limiting height data can be applied to walls where gypsum board is installed vertically on both flanges of the stud, for the full height of the wall and attached to the top and bottom tracks. ProSTUD composite data is based on the 2021 International Building Code, and was tested and analyzed in accordance with AISI S916 and ICC-ES AC86. Composite limiting height tables for ProSTUD members are available starting on page 16 of this catalog.

**It is important to note that a wall designed using limiting heights from composite tables must be constructed consistent with the assembly as it was tested per AISI S916 and ICC-ES AC86.**

### Not to be used with:

- Deflection Tracks
- Resilient Channel
- Sound Clips
- 1/2" Gypsum Board
- Horizontally Installed Board

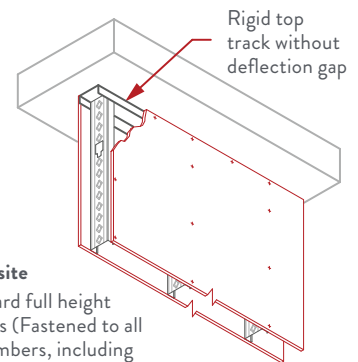

## Non-Composite Assemblies

Non-composite conditions are common in all structures. When the gypsum board stops at the ceiling level, but the stud continues to the deck, it is a non-composite condition. **Wall framing with Deflection Track, Resilient Channel (RC) or Sound Clips is a non-composite design since the screws attaching the gypsum board are not directly attached to the framing or top track.** While there may be advantages to contacting Technical Services or a Design Professional, many conditions can be covered by limiting heights tables shown in this catalog or at [clarkdietrich.com](http://clarkdietrich.com). When in doubt, call our complimentary Technical Services Hotline at 888-437-3244.

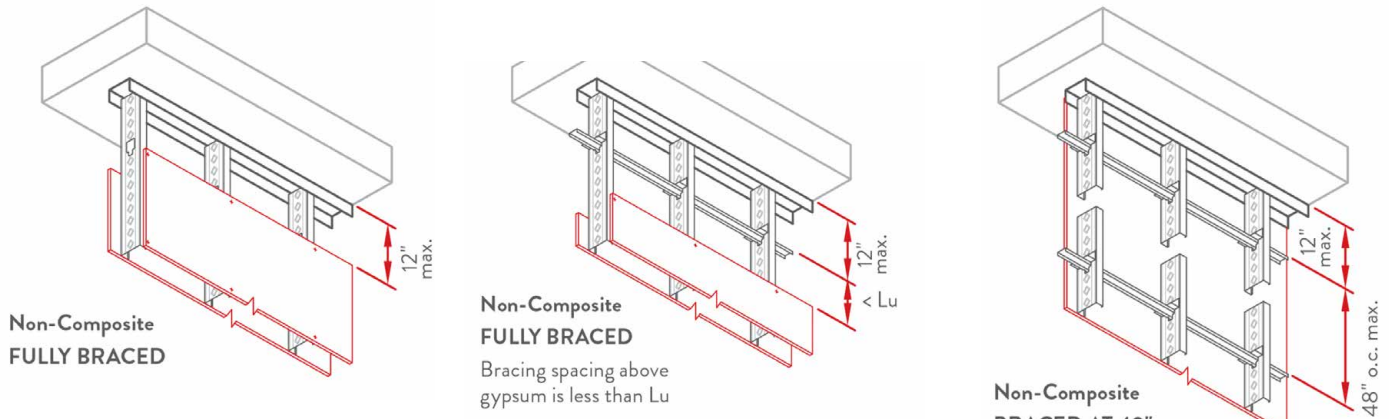

Distance of unbraced length (Lu) can be found in the physical and structural properties starting on page 6.

## Other Assemblies

### Chase Walls or Furred Walls

Chase and furred walls are common, but the conditions vary greatly depending on the building requirements. While non-composite tables may be used conservatively, when in doubt, contact our Technical Services Hotline at 888-437-3244 for chase wall designs.

### Ceilings

Interior ceilings are often supported by ProSTUD framing. The design criteria varies greatly based on the weight of the ceiling, bracing, and support points. You'll find a partial listing of ceiling span tables on page 24. Visit [clarkdietrich.com/ProSTUD](http://clarkdietrich.com/ProSTUD) for more comprehensive data.

## ClarkDietrich SubmittalPro® and iTools

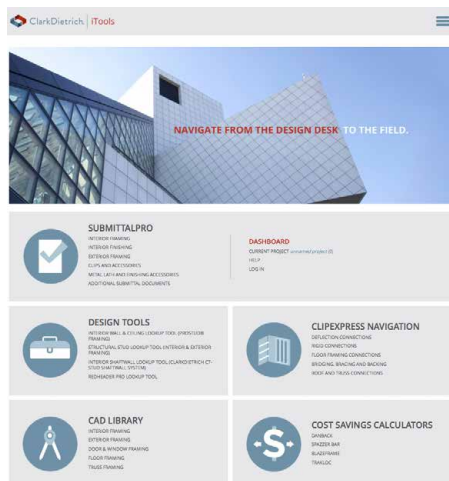

**SubmittalPro® and Lookup Tools**  
[itools.clarkdietrich.com](http://itools.clarkdietrich.com) – Mobile Friendly

**SubmittalPro®**  
 We built this online technical submittal generator tool to make your job easier. Use it to quickly view data on our products and create your final submittal documents.

**Interior Wall & Ceiling Lookup Tools**  
 Perform a fast, easy search by: design, limiting height, fire rating or STC sound rating.

Direct links to: UL Design Reports, STC sound tests and ProSTUD submittals.

**ProSTUD® 25 / 15mil Head-of-Wall (HOW) Composite Limiting Heights**  
w/ 30mil 2-1/2" Leg MaxTRAK®

5/8" Type X Gypsum Board

Width	Stud Member	Yield Strength	Spacing (in) o.c.	5psf			7.5psf			10psf		
				L/120	L/240	L/360	L/120	L/240	L/360	L/120	L/240	L/360
3-5/8"	ProSTUD 25 / 15 mil 362PDS125-15	50 ksi	12	19' - 9"	16' - 6"	14' - 6"	16' - 10" f	14' - 5"	12' - 8"	14' - 7" f	13' - 1"	11' - 3"
			16	18' - 7"	15' - 6"	13' - 7"	15' - 4" f	13' - 7"	11' - 10"	13' - 3" f	12' - 4"	10' - 3"
			24	15' - 10" f	13' - 7"	11' - 10"	12' - 11" f	11' - 10"	10' - 1"	11' - 2" f	10' - 7"	8' - 10"
4"	ProSTUD 25 / 15 mil 400PDS125-15	50 ksi	12	20' - 11"	17' - 6"	15' - 3"	18' - 3"	15' - 3"	13' - 4"	16' - 2" f	13' - 11"	12' - 1"
			16	19' - 9"	16' - 4"	14' - 4"	16' - 6" f	14' - 4"	12' - 6"	14' - 4" f	13' - 0"	11' - 2"
			24	16' - 6" f	14' - 4"	12' - 6"	13' - 6" f	12' - 6"	10' - 8"	11' - 8" f	11' - 3"	9' - 6"
6"	ProSTUD 25 / 15 mil 600PDS125-15	50 ksi	12	27' - 10" f	23' - 8"	20' - 8"	22' - 9" f	20' - 8"	18' - 1"	19' - 8" f	18' - 9"	16' - 5"
			16	24' - 1" f	21' - 11"	19' - 5"	19' - 8" f	19' - 2"	17' - 0"	17' - 1" f	17' - 1" f	15' - 2"
			24	19' - 8" f	19' - 2"	17' - 0"	16' - 1" f	16' - 1" f	14' - 9"	13' - 11" f	13' - 11" f	13' - 2"

**Notes:**

- Allowable HOW composite limiting heights were tested in accordance with AISI S916 and ICC-ES AC86.
- The tests were modified from the standards with the tracks fastened to the test fixture such that the wall stiffness included the track deformation.
- In accordance with current building codes and AISI design standards, the 1/3 Stress Increase for strength was not used.
- The composite limiting heights provided in the tables are based on a single layer of 5/8" Type X Gypsum Board from the following manufacturers: American, CertainTeed, Georgia Pacific, Continental, National, PABCO, and USG.
- The gypsum board must be applied full height in the vertical orientation to each stud flange and installed in accordance with ASTM C754 using minimum No. 6 Type S Drywall screws spaced as listed below:
  - Sheathing screws spaced a maximum of 16 in on-center to framing members (including bottom track) when studs spaced at 16 in or 12 in on-center.
  - Sheathing screws spaced a maximum of 12 in on-center to framing members (including bottom track) when studs spaced at 24 in on-center.
- #8 wafer head screws shall be used for attaching the stud to 30mil 2-1/2" Leg MaxTRAK (as top track) adhering to details below:
  - Stud to track connection must be installed as depicted in figure with a maximum gap of 7/8" between the web of the MaxTRAK and end of stud.
  - Slots in the MaxTRAK Legs allows for a total vertical movement of 1-1/2" (± 3/4") with screw centered in slots
  - Screws shall be placed in each flange of the stud at a minimum of 3/8" from the end of the stud
  - To permit head of wall deflection, gypsum board must not be fastened directly to the MaxTRAK
- No fasteners are required for attaching the stud to the bottom track except as detailed in ASTM C754.
- f** Adjacent to the height value indicates that flexural stress controls the allowable wall height.

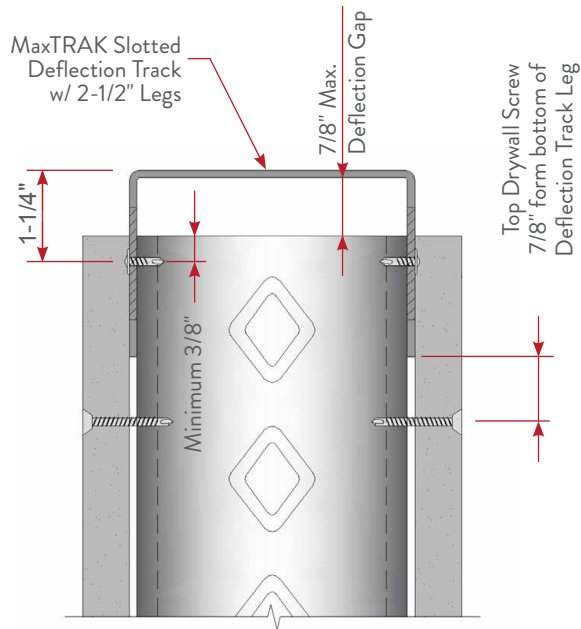

ProSTUD® 20 / 18mil Head-of-Wall (HOW) Composite Limiting Heights w/ 30mil 2-1/2" Leg MaxTRAK®				5/8" Type X Gypsum Board								
Width	Stud Member	Yield Strength	Spacing (in) o.c.	5psf			7.5psf			10psf		
				L/120	L/240	L/360	L/120	L/240	L/360	L/120	L/240	L/360
2-1/2"	ProSTUD 20 / 18 mil 250PDS125-18	70 ksi	12	17' - 5"	14' - 8"	12' - 10"	15' - 3"	12' - 10"	11' - 2"	13' - 10"	11' - 8"	10' - 2"
			16	16' - 8"	14' - 0"	12' - 3"	14' - 6"	12' - 3"	10' - 8"	13' - 2"	11' - 2" f	9' - 6"
			24	15' - 2"	12' - 10"	11' - 1"	13' - 2" f	11' - 2"	9' - 6"	11' - 5" f	10' - 2"	8' - 2"
3-5/8"	ProSTUD 20 / 18 mil 362PDS125-18	70 ksi	12	21' - 2"	17' - 8"	15' - 5"	18' - 6"	15' - 6"	13' - 5"	16' - 10"	14' - 1"	12' - 3"
			16	19' - 11"	16' - 8"	14' - 6"	17' - 5"	14' - 7"	12' - 8"	15' - 10"	13' - 3"	11' - 3"
			24	18' - 0"	15' - 0"	13' - 0"	15' - 9" f	13' - 2"	11' - 2"	13' - 7" f	11' - 11"	9' - 9"
4"	ProSTUD 20 / 18 mil 400PDS125-18	70 ksi	12	22' - 5"	18' - 8"	16' - 4"	19' - 7"	16' - 4"	14' - 3"	17' - 10"	14' - 10"	13' - 0"
			16	21' - 0"	17' - 7"	15' - 4"	18' - 4"	15' - 4"	13' - 5"	16' - 8"	13' - 11"	12' - 2"
			24	18' - 11"	15' - 10"	13' - 10"	16' - 6"	13' - 10"	12' - 1"	14' - 4" f	12' - 6"	10' - 6"
6"	ProSTUD 20 / 18 mil 600PDS125-18	70 ksi	12	30' - 1"	25' - 1"	21' - 11"	26' - 4"	21' - 11"	19' - 1"	23' - 11"	19' - 11"	17' - 4"
			16	28' - 1"	23' - 4"	20' - 5"	24' - 6"	20' - 5"	17' - 10"	21' - 6" f	18' - 7"	16' - 2"
			24	25' - 1"	20' - 11"	18' - 3"	20' - 9" f	18' - 3"	15' - 11"	18' - 0" f	16' - 7"	13' - 8"

**Notes:**

- Allowable HOW composite limiting heights were tested in accordance with AISI S916 and ICC-ES AC86.
  - The tests were modified from the standards with the tracks fastened to the test fixture such that the wall stiffness included the track deformation.
  - In accordance with current building codes and AISI design standards, the 1/3 Stress Increase for strength was not used.
  - The composite limiting heights provided in the tables are based on a single layer of 5/8" Type X Gypsum Board from the following manufacturers: American, CertainTeed, Georgia Pacific, Continental, National, PABCO, and USG.
  - The gypsum board must be applied full height in the vertical orientation to each stud flange and installed in accordance with ASTM C754 using minimum No. 6 Type S Drywall screws spaced as listed below:
    - Sheathing screws spaced a maximum of 16 in on-center to framing members (including bottom track) when studs spaced at 16 in or 12 in on-center.
    - Sheathing screws spaced a maximum of 12 in on-center to framing members (including bottom track) when studs spaced at 24 in on-center.
  - #8 wafer head screws shall be used for attaching the stud to 30mil 2-1/2" Leg MaxTRAK (as top track) adhering to details below:
    - Stud to track connection must be installed as depicted in figure with a maximum gap of 7/8" between the web of the MaxTRAK and end of stud.
    - Slots in the MaxTRAK Legs allows for a total vertical movement of 1-1/2" (± 3/4") with screw centered in slots
    - Screws shall be placed in each flange of the stud at a minimum of 3/8" from the end of the stud
    - To permit head of wall deflection, gypsum board must not be fastened directly to the MaxTRAK
  - No fasteners are required for attaching the stud to the bottom track except as detailed in ASTM C754.
- f** Adjacent to the height value indicates that flexural stress controls the allowable wall height.

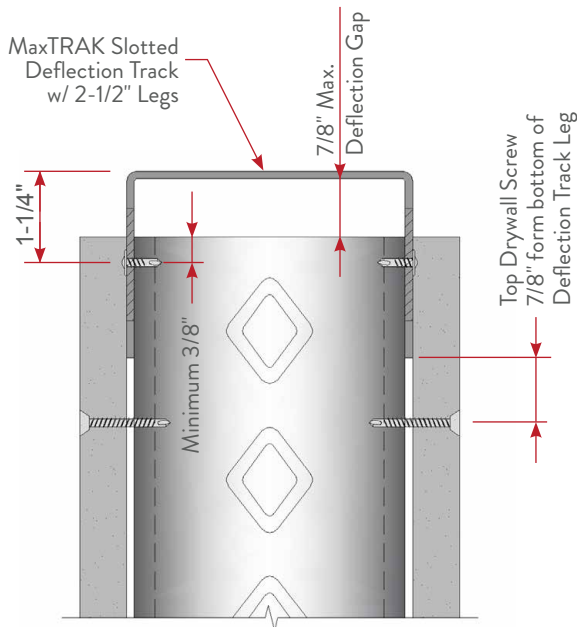

**ProSTUD® 25 / 15mil Head-of-Wall (HOW) Composite Limiting Heights**  
w/ 30mil 2-1/2" Leg Deflection Track

5/8" Type X Gypsum Board

Width	Stud Member	Yield Strength	Spacing (in) o.c.	5psf			7.5psf			10psf		
				L/120	L/240	L/360	L/120	L/240	L/360	L/120	L/240	L/360
3-5/8"	ProSTUD 25 / 15 mil 362PDS125-15	50 ksi	12	19' - 9"	16' - 6"	14' - 6"	16' - 10" f	14' - 5"	12' - 8"	14' - 7" f	13' - 1"	11' - 3"
			16	18' - 7"	15' - 6"	13' - 7"	15' - 4" f	13' - 7"	11' - 10"	13' - 3" f	12' - 4"	10' - 3"
			24	15' - 10" f	13' - 7"	11' - 10"	12' - 11" f	11' - 10"	10' - 1"	11' - 2" f	10' - 7"	8' - 10"
4"	ProSTUD 25 / 15 mil 400PDS125-15	50 ksi	12	20' - 11"	17' - 6"	15' - 3"	18' - 0" f	15' - 3"	13' - 4"	15' - 7" f	13' - 11"	12' - 1"
			16	19' - 9"	16' - 4"	14' - 4"	16' - 4" f	14' - 4"	12' - 6"	14' - 2" f	13' - 0"	11' - 2"
			24	16' - 6" f	14' - 4"	12' - 6"	13' - 6" f	12' - 6"	10' - 8"	11' - 8" f	11' - 3"	9' - 6"
6"	ProSTUD 25 / 15 mil 600PDS125-15	50 ksi	12	27' - 10" f	23' - 8"	20' - 8"	22' - 9" f	20' - 8"	18' - 1"	19' - 8" f	18' - 9"	16' - 5"
			16	24' - 1" f	21' - 11"	19' - 5"	19' - 8" f	19' - 2"	17' - 0"	17' - 1" f	17' - 1" f	15' - 2"
			24	19' - 8" f	19' - 2"	17' - 0"	16' - 1" f	16' - 1" f	14' - 9"	13' - 11" f	13' - 11" f	13' - 2"

**Notes:**

- Allowable HOW composite limiting heights were tested in accordance with AISI S916 and ICC-ES AC86.
- The tests were modified from the standards with the tracks fastened to the test fixture such that the wall stiffness included the track deformation.
- In accordance with current building codes and AISI design standards, the 1/3 Stress Increase for strength was not used.
- The composite limiting heights provided in the tables are based on a single layer of 5/8" Type X Gypsum Board from the following manufacturers: American, CertainTeed, Georgia Pacific, Continental, National, PABCO, and USG.
- The gypsum board must be applied full height in the vertical orientation to each stud flange and installed in accordance with ASTM C754 using minimum No. 6 Type S Drywall screws spaced as listed below:
  - Sheathing screws spaced a maximum of 16 in on-center to framing members (including bottom track) when studs spaced at 16 in or 12 in on-center.
  - Sheathing screws spaced a maximum of 12 in on-center to framing members (including bottom track) when studs spaced at 24 in on-center.
- No fasteners are required for attaching the stud to the Deflection track at the top except as detailed in ASTM C754.:
  - Stud to track connection must be installed as depicted in figure with a maximum gap of 7/8" between the web of the Deflection track and end of stud.
  - The maximum amount of total vertical movement (compression + extension) cannot exceed 1-1/2".
  - To permit head of wall deflection, gypsum board must not be fastened directly to the Deflection track.
- No fasteners are required for attaching the stud to the bottom track except as detailed in ASTM C754.
- A spazzer spacing bar shall be installed in the punchouts immediately adjacent to the top track (Deflection Track) to hold studs in place.
- f** Adjacent to the height value indicates that flexural stress controls the allowable wall height.

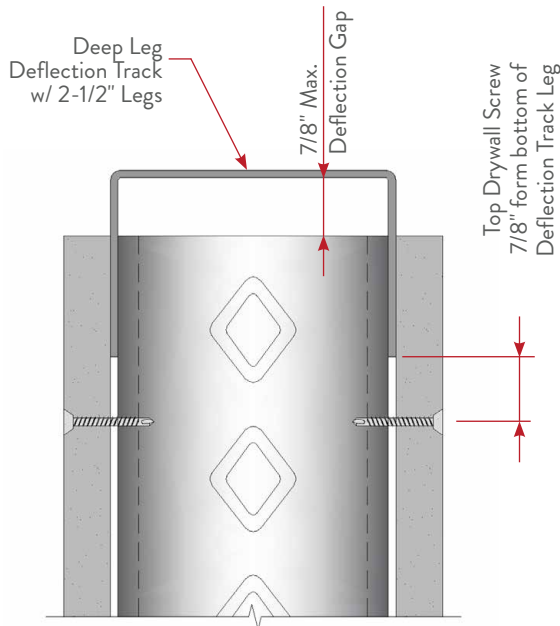

**ProSTUD® 20 / 18mil Head-of-Wall (HOW) Composite Limiting Heights**  
w/ 30mil 2-1/2" Leg Deflection Track

5/8" Type X Gypsum Board

Width	Stud Member	Yield Strength	Spacing (in) o.c.	5psf			7.5psf			10psf		
				L/120	L/240	L/360	L/120	L/240	L/360	L/120	L/240	L/360
2-1/2"	ProSTUD 20 / 18 mil 250PDS125-18	70 ksi	12	16' - 6"	14' - 1"	12' - 4"	14' - 6"	12' - 4"	10' - 9"	13' - 3"	11' - 2"	9' - 9"
			16	15' - 11"	13' - 5"	11' - 8"	13' - 11"	11' - 8"	10' - 3"	12' - 8"	10' - 8"	9' - 0"
			24	14' - 5"	12' - 2"	10' - 7"	12' - 6" f	10' - 7"	8' - 11"	10' - 10" f	9' - 6"	--
3-5/8"	ProSTUD 20 / 18 mil 362PDS125-18	70 ksi	12	21' - 2"	17' - 8"	15' - 5"	18' - 6"	15' - 6"	13' - 5"	16' - 10"	14' - 1"	12' - 3"
			16	19' - 11"	16' - 8"	14' - 6"	17' - 5"	14' - 7"	12' - 8"	15' - 10"	13' - 3"	11' - 3"
			24	18' - 0"	14' - 11"	13' - 0"	15' - 9"	13' - 1"	11' - 1"	13' - 7" f	11' - 10"	9' - 9"
4"	ProSTUD 20 / 18 mil 400PDS125-18	70 ksi	12	22' - 5"	18' - 7"	16' - 4"	19' - 7"	16' - 3"	14' - 3"	17' - 10"	14' - 9"	12' - 11"
			16	20' - 10"	17' - 3"	15' - 2"	18' - 3"	15' - 1"	13' - 3"	16' - 7"	13' - 9"	12' - 1"
			24	18' - 7"	15' - 5"	13' - 6"	16' - 3"	13' - 6"	11' - 9"	14' - 2" f	12' - 3"	10' - 2"
6"	ProSTUD 20 / 18 mil 600PDS125-18	70 ksi	12	29' - 6"	24' - 8"	21' - 9"	25' - 9"	21' - 6"	19' - 0"	22' - 5" f	19' - 7"	17' - 3"
			16	27' - 9"	23' - 2"	20' - 5"	23' - 4" f	20' - 3"	17' - 10"	20' - 3" f	18' - 5"	16' - 2"
			24	24' - 3" f	20' - 11"	18' - 3"	19' - 10" f	18' - 3"	15' - 11"	17' - 2" f	16' - 7"	13' - 8"

**Notes:**

- Allowable HOW composite limiting heights were tested in accordance with AISI S916 and ICC-ES AC86.
  - The tests were modified from the standards with the tracks fastened to the test fixture such that the wall stiffness included the track deformation.
  - In accordance with current building codes and AISI design standards, the 1/3 Stress Increase for strength was not used.
  - The composite limiting heights provided in the tables are based on a single layer of 5/8" Type X Gypsum Board from the following manufacturers: American, CertainTeed, Georgia Pacific, Continental, National, PABCO, and USG.
  - The gypsum board must be applied full height in the vertical orientation to each stud flange and installed in accordance with ASTM C754 using minimum No. 6 Type S Drywall screws spaced as listed below:
    - Sheathing screws spaced a maximum of 16 in on-center to framing members (including bottom track) when studs spaced at 16 in or 12 in on-center.
    - Sheathing screws spaced a maximum of 12 in on-center to framing members (including bottom track) when studs spaced at 24 in on-center.
  - No fasteners are required for attaching the stud to the Deflection track at the top except as detailed in ASTM C754.:
    - Stud to track connection must be installed as depicted in figure with a maximum gap of 7/8" between the web of the Deflection track and end of stud.
    - The maximum amount of total vertical movement (compression + extension) cannot exceed 1-1/2".
    - To permit head of wall deflection, gypsum board must not be fastened directly to the Deflection track.
  - No fasteners are required for attaching the stud to the bottom track except as detailed in ASTM C754.
  - A spazzer spacing bar shall be installed in the punchouts immediately adjacent to the top track (Deflection Track) to hold studs in place.
- f** Adjacent to the height value indicates that flexural stress controls the allowable wall height.

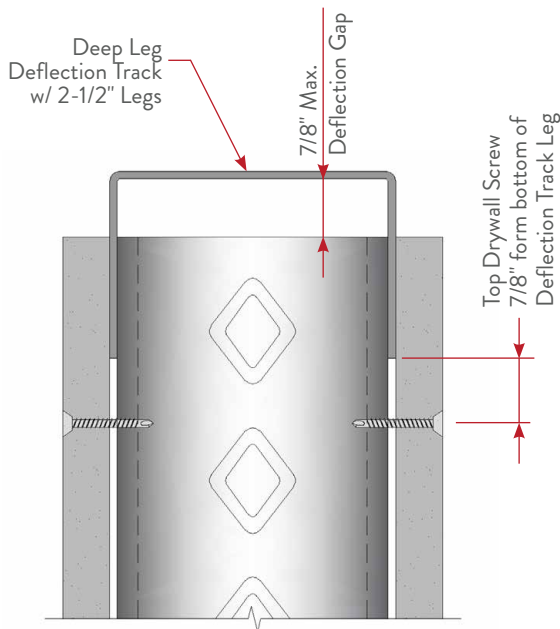

Complies with IBC 2021 • AISI S100 • AISI S220

**ProSTUD® Full Composite Limiting Heights**

**5/8" Type X Gypsum Board**

Width (in)	Stud member	Design thickness (in)	Yield strength (ksi)	Spacing (inches)	Lateral Load (psf)								
					5psf			7.5psf			10psf		
					L/120	L/240	L/360	L/120	L/240	L/360	L/120	L/240	L/360
1-5/8	ProSTUD 25 162PDS125-15	0.0158	50	12	14' 1"	11' 7"	10' 1"	12' 3"	10' 1"	8' 7"	11' 2"	9' 1"	—
				16	12' 9"	10' 6"	9' 0"	11' 2"	9' 1"	—	10' 2"	8' 1"	—
				24	11' 2"	9' 1"	—	9' 9"	—	—	8' 5"	—	—
	ProSTUD 20 162PDS125-18	0.0190	70	12	13' 2"	11' 5"	10' 0"	11' 6"	10' 0"	8' 5"	10' 6"	8' 9"	—
				16	12' 10"	11' 1"	9' 9"	11' 2"	9' 8"	7' 11"	10' 2"	8' 4"	—
				24	11' 10"	10' 3"	8' 6"	10' 4"	8' 5"	—	9' 2"	—	—
	ProSTUD 30 162PDS125-30	0.0312	33	12	16' 3"	12' 11"	11' 3"	14' 3"	11' 3"	9' 10"	12' 11"	10' 3"	8' 8"
				16	14' 9"	11' 9"	10' 3"	12' 11"	10' 3"	8' 8"	11' 9"	9' 2"	—
				24	12' 11"	10' 3"	8' 8"	11' 3"	8' 8"	—	10' 3"	—	—
	ProSTUD 33 162PDS125-33	0.0346	33	12	17' 0"	13' 6"	11' 10"	14' 10"	11' 10"	10' 4"	13' 6"	10' 9"	9' 3"
				16	15' 6"	12' 3"	10' 9"	13' 6"	10' 9"	9' 3"	12' 3"	9' 9"	—
				24	13' 6"	10' 9"	9' 3"	11' 10"	9' 3"	—	10' 9"	—	—
2-1/2	ProSTUD 25 250PDS125-15	0.0158	50	12	17' 2"	14' 8"	13' 0"	15' 0"	12' 10"	11' 4"	13' 3" f	11' 8"	10' 4"
				16	15' 7"	13' 4"	11' 9"	13' 3" f	11' 8"	10' 4"	11' 5" f	10' 7"	9' 1"
				24	13' 3" f	11' 8"	10' 4"	10' 10" f	10' 2"	8' 6"	9' 4" f	8' 11"	—
	ProSTUD 20 250PDS125-18	0.0190	70	12	17' 5"	14' 8"	12' 11"	15' 3"	12' 10"	11' 3"	13' 10"	11' 8"	10' 3"
				16	16' 8"	14' 0"	12' 4"	14' 6"	12' 3"	10' 9"	13' 2"	11' 2" f	9' 9"
				24	15' 2"	12' 10"	11' 3"	13' 2" f	11' 2"	9' 10"	11' 5" f	10' 2"	8' 5"
	ProSTUD 30 250PDS125-30	0.0312	33	12	19' 9"	16' 3"	14' 4"	17' 3"	14' 2"	12' 6"	15' 8"	12' 11"	11' 4"
				16	17' 11"	14' 9"	13' 0"	15' 8"	12' 11"	11' 4"	14' 3"	11' 9"	10' 4"
				24	15' 8"	12' 11"	11' 4"	13' 8" f	11' 3"	9' 11"	12' 5"	10' 3"	8' 8"
	ProSTUD 33 250PDS125-33	0.0346	33	12	20' 4"	16' 9"	14' 9"	17' 9"	14' 7"	12' 10"	16' 2"	13' 3"	11' 8"
				16	18' 6"	15' 2"	13' 5"	16' 2"	13' 3"	11' 8"	14' 8"	12' 1"	10' 7"
				24	16' 2"	13' 3"	11' 8"	14' 1"	11' 7"	10' 3"	12' 10"	10' 7"	9' 1"
3-5/8	ProSTUD 25 362PDS125-15	0.0158	50	12	21' 6"	17' 1"	14' 11"	18' 4" f	14' 11"	13' 0"	15' 10" f	13' 7"	11' 10"
				16	19' 5" f	15' 6"	13' 7"	15' 10" f	13' 7"	11' 10"	13' 9" f	12' 4"	10' 7"
				24	15' 10" f	13' 7"	11' 10"	12' 11" f	11' 10"	10' 1"	11' 2" f	10' 7"	9' 0"
	ProSTUD 20 362PDS125-18	0.0190	70	12	22' 0"	18' 2"	15' 8"	19' 3"	15' 10"	13' 8"	17' 6"	14' 5"	12' 5"
				16	20' 6"	16' 10"	14' 7"	17' 11"	14' 9"	12' 9"	16' 3"	13' 5"	11' 6"
				24	18' 4"	15' 1"	13' 0"	15' 11" f	13' 2"	11' 4"	13' 9" f	12' 0"	10' 1"
	ProSTUD 30 362PDS125-30	0.0312	33	12	25' 8"	20' 5"	17' 10"	22' 5"	17' 10"	15' 7"	20' 5"	16' 2"	14' 2"
				16	23' 4"	18' 6"	16' 2"	20' 5"	16' 2"	14' 2"	18' 6"	14' 8"	12' 10"
				24	20' 5"	16' 2"	14' 2"	17' 10"	14' 2"	12' 3"	16' 2"	12' 10"	11' 0"
	ProSTUD 33 362PDS125-33	0.0346	33	12	26' 7"	21' 2"	18' 5"	23' 3"	18' 5"	16' 1"	21' 2"	16' 9"	14' 8"
				16	24' 2"	19' 2"	16' 9"	21' 2"	16' 9"	14' 8"	19' 2"	15' 3"	13' 4"
				24	21' 2"	16' 9"	14' 8"	18' 5"	14' 8"	12' 10"	16' 9"	13' 4"	11' 6"

**Notes:**

- Allowable composite limiting heights were tested in accordance with AISI S916 and ICC-ES AC86.
- Additional composite wall testing and analysis requirements of the SFIA Code Compliance Certification Program were also observed.
- In accordance with current building codes and AISI design standards, the 1/3 stress increase for strength was not used.
- The composite limiting heights provided in the tables are based on a single layer of 5/8" Type X Gypsum Board from the following manufacturers: American, CertainTeed, Georgia Pacific, Continental, National, PABCO, and USG.
- The gypsum board must be applied full height in the vertical orientation to each stud flange and installed in accordance with ASTM C754 using minimum No. 6 Type S drywall screws spaced as listed below:
  - Screws spaced a maximum of 16 in. o.c. to framing members (including top and bottom tracks) spaced at 16 in. or 12 in. o.c.
  - Screws spaced a maximum of 12 in. o.c. to framing members (including top and bottom tracks) spaced at 24 in. o.c.
- No fasteners are required for attaching the stud to the track except as detailed in ASTM C754.
- Stud end bearing must be a minimum of 1 inch.
- f** Adjacent to the height value indicates that flexural stress controls the allowable wall height.
- s** Adjacent to the height value indicates that shear/end reaction controls the allowable wall height.



# ProSTUD® Full Composite Limiting Heights 5/8" Type X Gypsum Board

Width (in)	Stud member	Design thickness (in)	Yield strength (ksi)	Spacing (inches)	Lateral Load (psf)								
					5psf			7.5psf			10psf		
					L/120	L/240	L/360	L/120	L/240	L/360	L/120	L/240	L/360
4	ProSTUD 25 400PDS125-15	0.0158	50	12	22' 8"	18' 0"	15' 9"	19' 1" f	15' 9"	13' 9"	16' 6" f	14' 4"	12' 6"
				16	20' 3" f	16' 4"	14' 4"	16' 6" f	14' 4"	12' 6"	14' 4" f	13' 0"	11' 3"
				24	16' 6" f	14' 4"	12' 6"	13' 6" f	12' 6"	10' 8"	11' 8" f	11' 3"	9' 6"
	ProSTUD 20 400PDS125-18	0.0190	70	12	22' 9"	18' 8"	16' 4"	19' 11"	16' 4"	14' 3"	18' 1"	14' 10"	13' 0"
				16	21' 4"	17' 7"	15' 4"	18' 8"	15' 4"	13' 5"	16' 11"	13' 11"	12' 2"
				24	19' 3"	15' 10"	13' 10"	16' 7" f	13' 10"	12' 1"	14' 4" f	12' 6"	10' 9"
	ProSTUD 30 400PDS125-30	0.0312	33	12	27' 5"	21' 9"	19' 0"	24' 0"	19' 0"	16' 8"	17' 9"	17' 4"	15' 1"
				16	24' 11"	19' 10"	17' 4"	21' 9"	17' 4"	15' 1"	19' 10"	15' 9"	13' 9"
				24	21' 9"	17' 4"	15' 1"	19' 0"	15' 1"	13' 2"	17' 4"	13' 9"	11' 10"
	ProSTUD 33 400PDS125-33	0.0346	33	12	27' 10"	22' 9"	20' 1"	24' 3"	19' 11"	17' 7"	22' 1"	18' 1"	15' 11"
				16	25' 3"	20' 8"	18' 3"	22' 1"	18' 1"	15' 11"	20' 1"	16' 5"	14' 6"
				24	22' 1"	18' 1"	15' 11"	19' 3"	15' 10"	13' 11"	17' 6"	14' 4"	12' 8"
6	ProSTUD 25 600PDS125-15	0.0158	50	12	27' 10" f	24' 2"	21' 5"	22' 9" f	21' 1"	18' 8"	19' 8" f	19' 2"	17' 0"
				16	24' 1" f	21' 11"	19' 5"	19' 8" f	19' 2"	17' 0"	17' 1" f	17' 1" f	15' 5"
				24	19' 8" f	19' 2"	17' 0"	16' 1" f	16' 1" f	14' 9"	13' 11" f	13' 11" f	13' 4"
	ProSTUD 20 600PDS125-18	0.0190	70	12	32' 1"	25' 6"	22' 3"	28' 1"	22' 3"	19' 5"	24' 4" f	20' 3"	17' 8"
				16	29' 10"	23' 8"	20' 8"	24' 10" f	20' 8"	18' 1"	21' 6" f	18' 9"	16' 5"
				24	25' 5" f	21' 1"	18' 5"	20' 9" f	18' 5"	16' 1"	18' 0" f	16' 9"	14' 6"
	ProSTUD 30 600PDS125-30	0.0312	33	12	36' 7"	29' 1"	25' 5"	32' 0"	25' 5"	22' 2"	29' 1"	23' 1"	20' 2"
				16	33' 3"	26' 5"	23' 1"	29' 1"	23' 1"	20' 2"	26' 5"	20' 11"	18' 4"
				24	29' 1"	23' 1"	20' 2"	25' 5"	20' 2"	17' 7"	22' 6" f	18' 4"	—
	ProSTUD 33 600PDS125-33	0.0346	33	12	36' 8"	30' 1"	26' 6"	32' 0"	26' 3"	23' 2"	29' 1"	23' 10"	21' 0"
				16	33' 3"	27' 4"	24' 1"	29' 1"	23' 10"	21' 0"	26' 5"	21' 8"	19' 1"
				24	29' 1"	23' 10"	21' 0"	25' 5"	20' 10"	18' 4"	23' 1"	18' 11"	—

**Notes:**

- Allowable composite limiting heights were tested in accordance with AISI S916 and ICC-ES AC86.
  - Additional composite wall testing and analysis requirements of the SFIA Code Compliance Certification Program were also observed.
  - In accordance with current building codes and AISI design standards, the 1/3 stress increase for strength was not used.
  - The composite limiting heights provided in the tables are based on a single layer of 5/8" Type X Gypsum Board from the following manufacturers: American, CertainTeed, Georgia Pacific, Continental, National, PABCO, and USG.
  - The gypsum board must be applied full height in the vertical orientation to each stud flange and installed in accordance with ASTM C754 using minimum No. 6 Type S drywall screws spaced as listed below:
    - Screws spaced a maximum of 16 in. o.c. to framing members (including top and bottom tracks) spaced at 16 in. or 12 in. o.c.
    - Screws spaced a maximum of 12 in. o.c. to framing members (including top and bottom tracks) spaced at 24 in. o.c.
  - No fasteners are required for attaching the stud to the track except as detailed in ASTM C754.
  - Stud end bearing must be a minimum of 1 inch.
- f** Adjacent to the height value indicates that flexural stress controls the allowable wall height.  
**s** Adjacent to the height value indicates that shear/end reaction controls the allowable wall height.





## ProSTUD® 3-5/8" Sound Assemblies

Partition type	Assembly description	STC Rating / Test Report				
		ProSTUD 25 (15mil)	ProSTUD 20 (18mil)	ProSTUD 30mil	ProSTUD 33mil	
	3-5/8" ProSTUD 1 layer 5/8" Type X GWB on each side	@ 24" o.c.	43 TL09-539	40 TL19-091	37 TL20-412	36 TL13-197
	3-5/8" ProSTUD 3-1/2" R-13 unfaced insulation 1 layer 5/8" Type X GWB on each side	@ 24" o.c.	48 TL09-540	47 TL19-094	40 TL20-413	37 TL13-196
	3-5/8" ProSTUD 3-1/2" R-13 unfaced insulation 1 layer 5/8" Type X GWB on one side 2 layers 5/8" Type X GWB on the other side	@ 24" o.c.	49 TL13-167	51 TL19-092	40 TL13-202	42 TL13-195
	3-5/8" ProSTUD 3-1/2" R-13 unfaced insulation 2 layers 5/8" Type X GWB on each side	@ 24" o.c.	54 TL09-538	52 TL19-093	42 TL13-201	45 TL13-194
	3-5/8" ProSTUD 3-1/2" R-13 unfaced insulation RC-Deluxe w/ 1 layer 5/8" Type X GWB on one side 1 layer 5/8" Type X GWB on the other side	@ 24" o.c.	54 TL18-302	53 TL19-097	48 TL20-414	50 TL16-369
	3-5/8" ProSTUD 3-1/2" R-13 unfaced insulation RC-Deluxe w/ 2 layers 5/8" Type X GWB on one side 1 layer 5/8" Type X GWB on the other side	@ 24" o.c.	59 TL09-543	58 TL19-096	55 TL20-415	56 TL16-370
	3-5/8" ProSTUD 3-1/2" R-13 unfaced insulation RC-Deluxe w/ 2 layers 5/8" Type X GWB on one side 2 layers 5/8" Type X GWB on the other side	@ 24" o.c.	62 TL13-181	60 TL19-095	58 TL20-416	58 TL13-200

**Notes:**

- Sound assemblies are certified by Western Electro-Acoustic Laboratories.
- NVLAP accredited for ASTM E90 & E413, ISO Certified.
- See STC test reports at [www.clarkdietrich.com/ProSTUD](http://www.clarkdietrich.com/ProSTUD) for detailed requirements of construction of wall assembly. Contact ClarkDietrich Technical Services at 888-437-3244 for questions about ProSTUD sound assemblies.

For Resilient Channel Installation Guidelines see: [www.clarkdietrich.com/RC](http://www.clarkdietrich.com/RC)

Visit [itools.clarkdietrich.com](http://itools.clarkdietrich.com) for a complete list of sound ratings.

Complies with IBC 2021 • AISI S100 • AISI S220

## ProSTUD 1-5/8" Stud Chase Sound Assemblies

### Two parallel rows

Gypsum type	Side A	Side B	Insulation type	Stud spacing	STC Rating	Test report	Partition type
					ProSTUD 25 (15mil)		
5/8" Type X	1 layer	1 layer	R-13* unfaced	24"	55	TL09-590	1 Similar
5/8" Type X	1 layer	2 layers	R-13* unfaced	24"	59	TL09-591	1 Similar
5/8" Type X	2 layers	2 layers	R-13* unfaced	24"	61	TL09-592	1

## ProSTUD 2-1/2" Stud Chase Sound Assemblies

### Staggered in opposite walls

Gypsum type	Side A	Side B	Insulation type	Stud spacing	STC Rating	Test report	Partition type
					ProSTUD 25 (15mil)		
5/8" Type X	1 layer	1 layer	R-13* unfaced*	24"	58	TL09-593	2 Similar
5/8" Type X	1 layer	2 layers	R-13* unfaced*	24"	63	TL09-594	2 Similar
5/8" Type X	2 layers	2 layers	R-13* unfaced*	24"	65	TL09-595	2

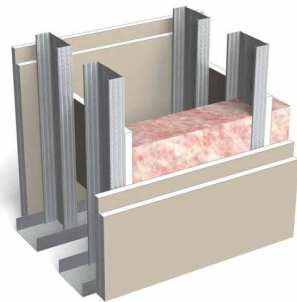

Partition  
Type 1

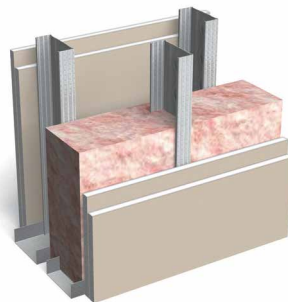

Partition  
Type 2

### Notes:

- Sound Assemblies are certified by Western Electro-Acoustic Laboratories.
- NVLAP Accredited for ASTM E90 & E413, ISO Certified.
- See STC test reports at [www.clarkdietrich.com/ProSTUD](http://www.clarkdietrich.com/ProSTUD) for detailed requirements of construction of wall assembly.

\* Values are the same for R-11 insulation.

Contact ClarkDietrich Technical Services at 888-437-3244 for questions about ProSTUD sound assemblies.

### ProSTUD® Single Stud Wall—Fire Assemblies<sup>A</sup>

UL design no.	Hourly rating	ProSTUD minimum thickness	ProSTUD minimum depth
U403	2	ProSTUD 20 (18mil)	3-5/8"
U407	1/2 or 1	ProSTUD 25 (15mil)	3-5/8"
U408	2	ProSTUD 20 (18mil)	3-5/8"
U411	2	ProSTUD 25 (15mil)	2-1/2"
U412	2	ProSTUD 25 (15mil)	1-5/8"
U419	1, 2, 3 or 4	ProSTUD 25 (15mil)	(See Table 1 below)
U421	2	ProSTUD 25 (15mil)	3-5/8"
U431	4	ProSTUD 20 (18mil)	3-5/8"
U435	3 or 4	ProSTUD 25 (15mil)	1-5/8"
U442*	1	ProSTUD 33MIL	2-1/2"
U450	1 or 3	ProSTUD 20 (18mil)	3-5/8"
U451	1	ProSTUD 20 (18mil)	2-1/2"
U454	2	ProSTUD 20 (18mil)	2-1/2"
U463	3 or 4	ProSTUD 20 (18mil)	1-5/8"
U465	1	ProSTUD 20 (18mil)	3-5/8"
U471	1-1/2	ProSTUD 20 (18mil)	3-5/8"
U475	1, 2 or 3	ProSTUD 20 (18mil)	3-5/8"
U478	3	ProSTUD 20 (18mil)	1-5/8"
U484*	2	ProSTUD 33MIL	2-1/2"
U488*	1	ProSTUD 33MIL	2-1/2"
U490	4	ProSTUD 20 (18mil)	2-1/2"
U491	2	ProSTUD 20 (18mil)	3-5/8"
U494	1	ProSTUD 20 (18mil)	2-1/2"
U495	1 or 2	ProSTUD 20 (18mil)	3-5/8"
U496	1	ProSTUD 20 (18mil)	1-5/8"

UL design no.	Hourly rating	ProSTUD minimum thickness	ProSTUD minimum depth
V410	2	ProSTUD 20 (18mil)	1-5/8"
V412	2	ProSTUD 20 (18mil)	3-5/8"
V416	1	ProSTUD 20 (18mil)	3-5/8"
V417	1	ProSTUD 20 (18mil)	3-5/8"
V418	2	ProSTUD 20 (18mil)	1-5/8"
V419	2	ProSTUD 20 (18mil)	2-1/2"
V425	1	ProSTUD 20 (18mil)	2-1/2"
V435	1	ProSTUD 20 (18mil)	3-5/8"
V438	1, 2, 3 or 4	ProSTUD 25 (15mil)	(See Table 1 below)
V443	4	ProSTUD 20 (18mil)	3-5/8"
V444	1	ProSTUD 20 (18mil)	3-5/8"
V448	1	ProSTUD 20 (18mil)	3-5/8"
V449	2	ProSTUD 20 (18mil)	3-5/8"
V450	1	ProSTUD 25 (15mil)	3-5/8"
V450	2	ProSTUD 25 (15mil)	2-1/2"
V452	1 or 2	ProSTUD 20 (18mil)	3-5/8"
V453*	1-1/2	ProSTUD 33MIL	6"
V461*	1	ProSTUD 33MIL	3-5/8"
V476	1 or 3	ProSTUD 20 (18mil)	3-5/8"
V477	1, 2, 3 or 4	ProSTUD 25 (15mil)	(See Table 1 below)
V487	2	ProSTUD 20 (18mil)	1-5/8"
V489	1, 2, 3 or 4	ProSTUD 25 (15mil)	(See Table 1 below)
V498	1, 2, 3 or 4	ProSTUD 25 (15mil)	(See Table 1 below)
W411	1/2 or 1	ProSTUD 25 (15mil)	3-5/8"
W415	1 or 2	ProSTUD 20 (18mil)	2-1/2"
W424	1	ProSTUD 25 (15mil)	3-5/8"

### ProSTUD Chase or Double Stud—Fire Assemblies<sup>A</sup>

UL design no.	Hourly rating	ProSTUD minimum thickness	ProSTUD minimum depth
U420	2	ProSTUD 25 (15mil)	1-5/8"
U436	1, 2, or 3	ProSTUD 20 (18mil)	1-5/8"
U444	2	ProSTUD 25 (15mil)	1-5/8"
U445*	1	ProSTUD 33 (33mil)	1-5/8"
U466	1	ProSTUD 20 (18mil)	2-1/2"
U493	2	ProSTUD 25 (15mil)	2-1/2"
V437	1	ProSTUD 20 (18mil)	1-5/8"

UL design no.	Hourly rating	ProSTUD minimum thickness	ProSTUD minimum depth
V442	2	ProSTUD 25 (15mil)	1-5/8"
V464	1	ProSTUD 25 (15mil)	3-5/8"
V469*	1	ProSTUD 33 (33mil)	2-1/2"
V469	2	ProSTUD 20 (18mil)	2-1/2"
V488	1 or 2	ProSTUD 20 (18mil)	2-1/2"
V490*	1 or 2	ProSTUD 33 (33mil)	2-1/2"
V496	1 or 2	ProSTUD 20 (18mil)	2-1/2"

### ProSTUD Table 1: Minimum Depth of ProSTUD Required<sup>A</sup>

Hourly rating	Min. stud depth (in)	No. of layers and thickness of gypsum board	UL U419	UL V438	UL V477	UL V489	UL V498
1	2-1/2"	1 layer, 1/2"	—	—	—	✓	—
1	3-5/8"	1 layer, 5/8"	✓	✓	✓	✓	✓
2	1-5/8"	2 layer, 1/2"	✓	✓	✓	✓	✓
2	1-5/8"	2 layer, 5/8"	✓	—	✓	✓	✓
2	2-1/2"	2 layer, 5/8"	—	✓	—	—	—
3	1-5/8"	3 layer, 1/2"	✓	✓	✓	✓	✓
3	1-5/8"	3 layer, 5/8"	✓	✓	✓	✓	✓
4	1-5/8"	4 layer, 1/2"	✓	✓	✓	✓	✓
4	1-5/8"	4 layer, 5/8"	✓	✓	✓	✓	✓

**Notes:**

<sup>A</sup>See UL listing for detailed requirements of construction of tested assembly.

\*ProSTUD meets or exceeds the description of the generic stud/track listed in the UL assembly.



## Deep Leg Deflection Track Systems

Head-of-wall vertical deep leg deflection track systems are required to allow the top of the wall stud to float within the top track legs. This condition allows for vertical live load movement of the primary structure without transferring axial loads to the interior drywall studs. A gap (determined by the Engineer of Record) is required between the top of the wall stud and the deflection track.

- **Wall framing with Deflection Track is a non-composite design since the screws attaching the gypsum board are not directly attached to the top track. (NEW) information on Head-of-Wall Composite systems using deflection track can be found on page 10.**

ProSTUD® Drywall Framing studs can be used with the three Deep Leg Track Systems listed below:

### ProTRAK® Deep Leg Track

ProTRAK deep leg track is available with leg lengths of 2", 2-1/2" and 3" long. The wall studs are not fastened to the deflection track, and a row of lateral bracing is required within 12" of the deep leg track to prevent rotation and lateral movement of the studs. The deflection track system must be designed for the end reaction of the wall studs (point loads) and for the specific gap required for vertical deflection.

#### ProTRAK® Allowable Lateral Loads and Wall Heights

Deflection track system	2" Leg Track with 1/2" Gap		2-1/2" Leg Track with 3/4" Gap		3" Leg Track with 1" Gap	
	Allowable load (lbs)	Limiting wall height	Allowable load (lbs)	Limiting wall height	Allowable load (lbs)	Limiting wall height
ProTRAK 25	36	10' 8"	24	7' 2"	18	5' 4"
ProTRAK 20	52	15' 6"	34	10' 4"	26	7' 9"
ProTRAK 30MIL	92	27' 6"	61	18' 4"	46	13' 9"
ProTRAK 33MIL	113	33' 10"	75	22' 7"	56	16' 11"

#### Notes:

- Limiting wall heights are based on studs spaced at 16" o.c. and an interior lateral load of 5psf.
- Stud members must be analyzed independently of the track system. Use [www.iProSTUD.com](http://www.iProSTUD.com) to check limiting wall heights for ProSTUD members.
- Stud failure modes relating to the deflection track connection (shear, web crippling, etc.) must be checked separately.

### Structural Deep Leg Track (18ga & 16ga)

Structural Deep Leg Track systems are installed the same as the ProTRAK deep leg track system but are designed to handle tall wall systems.

For structural deep leg track allowable loads, contact Technical Services at 888-437-3244 or visit [clarkdietrich.com](http://clarkdietrich.com).

### Slotted Deflection Track from ClarkDietrich

The slotted deflection track is attached to the wall studs through vertical slots using wafer head screws, creating a positive connection that allows for vertical movement and also eliminates the requirement for lateral bracing near the top of the wall stud.

#### MaxTrak® Allowable Lateral Loads and Wall Heights

Deflection track system	ProSTUD 25 (15mil, 50ksi)		ProSTUD 20 (18mil, 70ksi)		ProSTUD 30mil (33ksi)		ProSTUD 33mil (33ksi)	
	Allowable load (lbs)	Limiting wall height	Allowable load (lbs)	Limiting wall height	Allowable load (lbs)	Limiting wall height	Allowable load (lbs)	Limiting wall height
MaxTrak 30MIL	45	13' 6"	76	22' 10"	148	44' 4"	148	44' 4"
MaxTrak 33MIL	52	15' 7"	88	26' 5"	156	46' 10"	156	46' 10"

#### Notes:

- Allowable loads are based on screws through the slots located 1-1/4" from the track web.
- #8 minimum wafer head screws shall be used for stud-track connection.
- The above table is applicable to ProSTUD members only. ProSTUD allowable heights must be checked also.
- Allowable heights are based on 5psf and wall stud spacing at 16" o.c. with a max. gap of 7/8"

Complete information on Allowable Loads is available at [clarkdietrich.com](http://clarkdietrich.com).

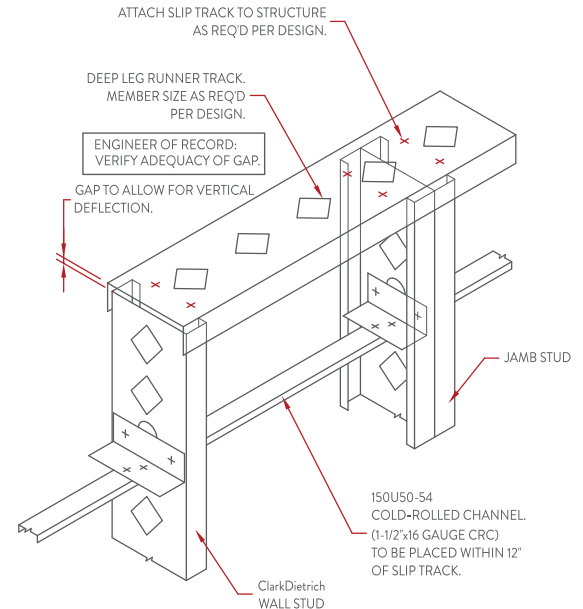

### 1 DEEP LEG DEFLECTION TRACK DETAIL WITH LATERAL BRACING WITHIN 12" OF SLIP TRACK

Details shown are for example only. The engineer of record of the project is responsible for the design of the connection to the structure. Additional connection details can be found at [clarkdietrich.com](http://clarkdietrich.com).

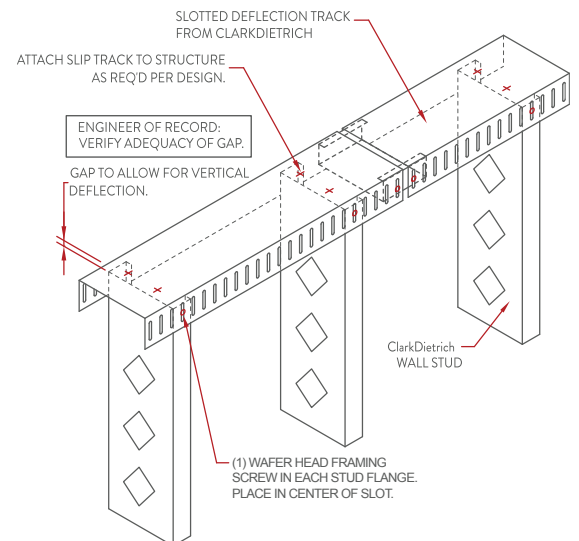

### 2 SLOTTED DEFLECTION TRACK DETAIL WITH TRACK SPLICE

ClarkDietrich offers both the MaxTrak® Slotted Deflection Track and BlazeFrame® Integrated Fire Stop System. Find more information on these systems at [clarkdietrich.com](http://clarkdietrich.com).

**ProSTUD® Allowable Ceiling Spans**

**Deflection Limit L/240**

Section	F <sub>y</sub> (ksi)	4psf Lateral Support of Compression Flange						6psf Lateral Support of Compression Flange					
		Unsupported joist spacing (in) o.c.			Mid-span joist spacing (in) o.c.			Unsupported joist spacing (in) o.c.			Mid-span joist spacing (in) o.c.		
		12	16	24	12	16	24	12	16	24	12	16	24
162PDS125-15	50	7' 3"	6' 8"	5' 11"	7' 10"	7' 2"	6' 3"	6' 5"	5' 11"	5' 3"	6' 10"	6' 3"	5' 5"
250PDS125-15	50	8' 4"	7' 8"	6' 11"	10' 11"	9' 11"	8' 8"	7' 5"	6' 11"	6' 2"	9' 7"	8' 8"	7' 7"
362PDS125-15	50	9' 2"	8' 6"	7' 7"	12' 9"	11' 8"	10' 3"	8' 3"	7' 7"	6' 9"	11' 3"	10' 3"	8' 11" e
400PDS125-15	50	9' 5"	8' 9"	7' 10"	13' 1"	12' 0"	10' 7" e	8' 6"	7' 10"	6' 11" e	11' 7" e	10' 7" e	9' 3" e
600PDS125-15	50	10' 8"	9' 10"	8' 10"	15' 0"	13' 9"	12' 2"	9' 6"	8' 10"	7' 11"	13' 3"	12' 2"	9' 11" e
162PDS125-18	70	7' 10"	7' 3"	6' 6"	8' 4"	7' 7"	6' 8"	7' 1"	6' 6"	5' 9"	7' 4"	6' 8"	5' 10"
250PDS125-18	70	9' 0"	8' 5"	7' 7"	11' 9"	10' 8"	9' 4"	8' 2"	7' 7"	6' 9"	10' 3"	9' 4"	8' 2"
362PDS125-18	70	9' 11"	9' 2"	8' 3"	14' 1"	12' 11"	11' 6"	8' 11"	8' 3"	7' 5"	12' 6"	11' 6"	10' 2"
400PDS125-18	70	10' 2"	9' 5"	8' 6"	14' 6"	13' 4"	11' 10"	9' 2"	8' 6"	7' 8"	12' 11"	11' 10"	10' 6"
600PDS125-18	70	11' 10"	10' 11"	9' 10"	16' 10"	15' 6"	13' 10"	10' 7"	9' 10"	8' 10"	15' 0"	13' 10"	12' 3"
162PDS125-30	33	9' 4"	8' 7"	7' 8"	9' 10"	9' 0"	7' 10"	8' 3"	7' 8"	6' 10"	8' 7"	7' 10"	6' 10"
250PDS125-30	33	10' 4"	9' 7"	8' 6"	13' 8"	12' 5"	10' 10"	9' 3"	8' 6"	7' 8"	11' 11"	10' 10"	9' 6"
362PDS125-30	33	11' 3"	10' 5"	9' 4"	16' 2"	15' 0"	13' 6"	10' 1"	9' 4"	8' 5"	14' 7"	13' 6"	12' 0"
400PDS125-30	33	11' 7"	10' 9"	9' 8"	16' 8"	15' 6"	13' 11"	10' 5"	9' 8"	8' 8"	15' 0"	13' 11"	12' 5"
600PDS125-30	33	13' 1"	12' 2"	10' 11"	18' 11"	17' 6"	15' 8"	11' 9"	10' 11"	9' 10"	17' 0"	15' 8"	14' 1"
162PDS125-33	33	9' 9"	9' 0"	8' 0"	10' 4"	9' 4"	8' 2"	8' 8"	8' 0"	7' 1"	9' 0"	8' 2"	7' 2"
250PDS125-33	33	10' 9"	9' 11"	8' 10"	14' 3"	12' 11"	11' 3"	9' 7"	8' 10"	7' 11"	12' 5"	11' 3"	9' 10"
362PDS125-33	33	11' 8"	10' 9"	9' 8"	16' 8"	15' 5"	13' 11"	10' 5"	9' 8"	8' 8"	15' 0"	13' 11"	12' 6"
400PDS125-33	33	12' 0"	11' 1"	9' 11"	17' 2"	15' 11"	14' 4"	10' 9"	9' 11"	8' 11"	15' 5"	14' 4"	12' 10"
600PDS125-33	33	13' 6"	12' 6"	11' 3"	19' 6"	18' 1"	16' 3"	12' 2"	11' 3"	10' 1"	17' 6"	16' 3"	14' 7"

**ProSTUD Allowable Ceiling Spans**

**Deflection Limit L/360**

Section	F <sub>y</sub> (ksi)	4psf Lateral Support of Compression Flange						6psf Lateral Support of Compression Flange					
		Unsupported joist spacing (in) o.c.			Mid-span joist spacing (in) o.c.			Unsupported joist spacing (in) o.c.			Mid-span joist spacing (in) o.c.		
		12	16	24	12	16	24	12	16	24	12	16	24
162PDS125-15	50	6' 10"	6' 3"	5' 5"	6' 10"	6' 3"	5' 5"	6' 0"	5' 5"	4' 9"	6' 0"	5' 5"	4' 9"
250PDS125-15	50	8' 4"	7' 8"	6' 11"	9' 7"	8' 8"	7' 7"	7' 5"	6' 11"	6' 2"	8' 4"	7' 7"	6' 8"
362PDS125-15	50	9' 2"	8' 6"	7' 7"	12' 9"	11' 7"	10' 1"	8' 3"	7' 7"	6' 9"	11' 2"	10' 1"	8' 10" e
400PDS125-15	50	9' 5"	8' 9"	7' 10"	13' 1"	12' 0"	10' 7" e	8' 6"	7' 10"	6' 11" e	11' 7" e	10' 7" e	9' 3" e
600PDS125-15	50	10' 8"	9' 10"	8' 10"	15' 0"	13' 9"	12' 2"	9' 6"	8' 10"	7' 11"	13' 3"	12' 2"	9' 11" e
162PDS125-18	70	7' 4"	6' 8"	5' 10"	7' 4"	6' 8"	5' 10"	6' 5"	5' 10"	5' 1"	6' 5"	5' 10"	5' 1"
250PDS125-18	70	9' 0"	8' 5"	7' 7"	10' 3"	9' 4"	8' 2"	8' 2"	7' 7"	6' 9"	9' 0"	8' 2"	7' 2"
362PDS125-18	70	9' 11"	9' 2"	8' 3"	13' 9"	12' 6"	10' 11"	8' 11"	8' 3"	7' 5"	12' 0"	10' 11"	9' 6"
400PDS125-18	70	10' 2"	9' 5"	8' 6"	14' 6"	13' 4"	11' 8"	9' 2"	8' 6"	7' 8"	12' 10"	11' 8"	10' 2"
600PDS125-18	70	11' 10"	10' 11"	9' 10"	16' 10"	15' 6"	13' 10"	10' 7"	9' 10"	8' 10"	15' 0"	13' 10"	12' 3"
162PDS125-30	33	8' 7"	7' 10"	6' 10"	8' 7"	7' 10"	6' 10"	7' 6"	6' 10"	6' 0"	7' 6"	6' 10"	6' 0"
250PDS125-30	33	10' 4"	9' 7"	8' 6"	11' 11"	10' 10"	9' 6"	9' 3"	8' 6"	7' 8"	10' 5"	9' 6"	8' 3"
362PDS125-30	33	11' 3"	10' 5"	9' 4"	15' 11"	14' 6"	12' 8"	10' 1"	9' 4"	8' 5"	13' 11"	12' 8"	11' 1"
400PDS125-30	33	11' 7"	10' 9"	9' 8"	16' 8"	15' 6"	13' 9"	10' 5"	9' 8"	8' 8"	15' 0"	13' 9"	12' 0"
600PDS125-30	33	13' 1"	12' 2"	10' 11"	18' 11"	17' 6"	15' 8"	11' 9"	10' 11"	9' 10"	17' 0"	15' 8"	14' 1"
162PDS125-33	33	9' 0"	8' 2"	7' 2"	9' 0"	8' 2"	7' 2"	7' 10"	7' 2"	6' 3"	7' 10"	7' 2"	6' 3"
250PDS125-33	33	10' 9"	9' 11"	8' 10"	12' 5"	11' 3"	9' 10"	9' 7"	8' 10"	7' 11"	10' 10"	9' 10"	8' 7"
362PDS125-33	33	11' 8"	10' 9"	9' 8"	16' 8"	15' 0"	13' 2"	10' 5"	9' 8"	8' 8"	14' 5"	13' 2"	11' 6"
400PDS125-33	33	12' 0"	11' 1"	9' 11"	17' 2"	15' 11"	14' 3"	10' 9"	9' 11"	8' 11"	15' 5"	14' 3"	12' 5"
600PDS125-33	33	13' 6"	12' 6"	11' 3"	19' 6"	18' 1"	16' 3"	12' 2"	11' 3"	10' 1"	17' 6"	16' 3"	14' 7"

- Notes:**
- For unbraced sections, allowable moment is based on AISI S100 Specification Section F2 & F3 with weak axis and torsional unbraced length assumed to be the listed span (completely unbraced). For mid-span braced sections, allowable moment based on Section F2 & F3 with weak axis and torsional unbraced length assumed to be one-half of the listed span (bracing at mid-span).
  - Web crippling calculation based on bearing length = 1 inch.
  - Web crippling and shear capacity have not been reduced for punchouts. If web punchouts occur near support members must be checked for reduced shear and web crippling in accordance with the AISI S100 Specification.
  - Values are for simple span conditions.
  - e Web stiffeners required at support.

Complies with IBC 2021 • AISI S100 • AISI S220



## Allowable Screw Design Values (lbs)

Member designation	Thickness (mils)	Design thickness (in)	Yield (ksi)	Ultimate	#6 Screw (0.138" Dia., 5/16" Head)				#8 Screw (0.164" Dia., 5/16" Head)				#10 Screw (0.190" Dia., 0.34" Head)			
					Shear, lbs	1-Side	2-Side	Pullout, lbs	Shear, lbs	1-Side	2-Side	Pullout, lbs	Shear, lbs	1-Side	2-Side	Pullout, lbs
PDS125-15	15	0.0158	50	50	52	62	123	31	56	62	123	37	61	67	134	43
PDS125-18	18	0.0190	70	70	95	104	208	52	104	104	208	62	112	113	226	72
PDS125-19	19	0.0200	65	65	96	102	203	51	104	102	203	60	112	111	221	70
PDS125-30	30	0.0312	33	33	95	80	161	40	103	80	161	48	111	88	175	55
PDS125-33	33	0.0346	33	45	151	122	243	61	164	122	243	72	177	132	265	84

**Notes:**

- Allowable screw connection capacities are based on Section J4 of the AISI S100 Specification.
- When connecting materials of different steel thicknesses or tensile strengths, use the lowest values. Tabulated values assume two sheets of equal thickness are connected.
- Screw shear and tension capacities were developed using published screw manufacturer data and evaluation reports available at the time of publication.
- Screw capacities are based on Allowable Strength Design (ASD) and include a safety factor of 3.0.
- When multiple fasteners are used, screws are assumed to have a center-to-center spacing of at least three times the nominal diameter (d).
- Screws are assumed to have a center-of-screw to edge-of-steel dimension of at least 1-1/2 times the nominal diameter (d) of the screw.
- Tension capacity is based on the lesser of pullout capacity in sheet closest to screw tip, or pullover capacity for sheet closest to screw head (using head diameter).
- Screw capacities are governed by a conservative estimate of screw capacity, not by sheet steel failure.
- For higher screw capacities, especially for screw strength, use specific screws from specific manufacturer. See manufacturer's data for specific allowable values and installation instructions.

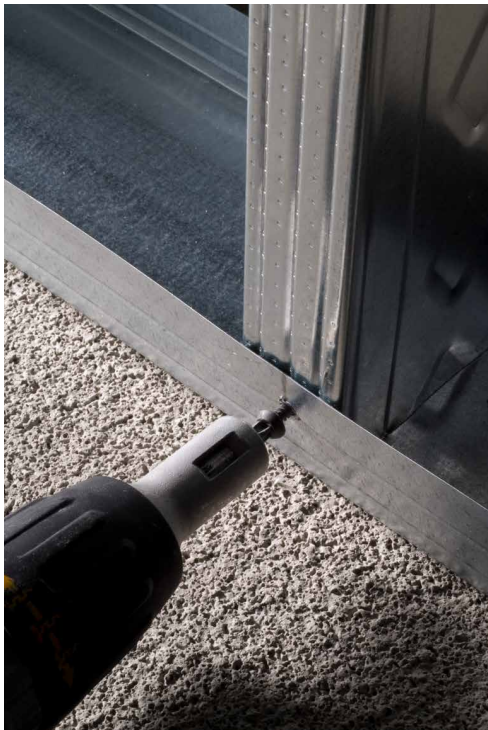
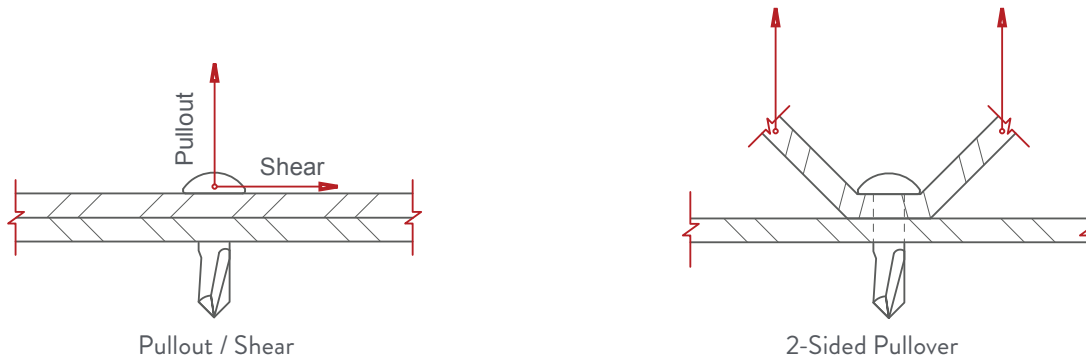

## Collaborative Services

### CLARKDIETRICH ENGINEERING SERVICES

#### Smarter engineering and technical expertise. It's support that extends beyond the structure itself.

From the initial design phase to jobsite installation, we are all about providing inventive, yet practical and hands-on know-how to help you think outside the box—or to help you just get it done.

ClarkDietrich Engineering Services is a full-service consulting firm that believes strongly in value engineering and customer input. Our engineering fees and lead times are competitive, and our customer service exceeds the industry standard with consistent point-of-contact through our regional project managers.

We offer Building Information Modeling (BIM) services that include specialty engineering collaborative design. We support the BIM movement by offering add-on tools that allow our products, and the rich data attached to them, to quickly be imported into digital designs. Our team is also comprised of LEED® Accredited professionals to consult on sustainable building design.

- Electronically sealed shop drawings and calculations
- Preliminary sizing and pre-bid engineering pricing
- Reference plan on large projects
- Detailed wall sections, full elevation opening design and C-stud truss design

Our technical services team provides immediate response to questions ranging from general installation to detailed specification requirements, and can deliver one-day turnaround on technical sizing. We are experts on industry standards such as AISI and ASTM, and a proud member of SFIA. Our team also supports our online product submittal system, SubmittalPro®, and our design/engineering software is available as a free download from [www.clarkdietrich.com](http://www.clarkdietrich.com).

- Product support and typical member sizing
- Framing detail recommendations
- Compliance and industry standards, such as AISI, ASTM and SFIA
- Engineering software and product submittal support
- LEED requirements support

### CLIP EXPRESS<sup>SM</sup>

#### Connections you can count on.

We know that having the right products, at the right time, and at the right price, is absolutely essential to getting the job done. ClarkDietrich Clip Express is your single source for the widest and most cost-effective array of rigid, deflection, bridging and general-purpose clips, connectors, supports and framing hardware for commercial and residential cold-formed steel framing.

With Clip Express, you get fully engineered, rigorously tested and precision-formed connectors each and every time. Many of our connectors were developed by, or in conjunction with, framing installers in order to deliver high-performance products for significant installed savings.

While you may find a cheaper price than ClarkDietrich, you won't find a lower overall cost or better value. We offer unmatched reach through numerous plants and engineering offices—and nationwide product availability.

And because staying on schedule is crucial, we ship most orders the same day they are received. We'll get it there when, how and where you need it. Our nationwide manufacturing and service facilities see to that.

- Industry's widest product selection available from one source
- Fast delivery options meet your deadlines
- Backed by the largest cold-formed steel framing and engineering company in the world
- Expert field representatives for comprehensive product, installation and sales training



## ProSTUD® & ProTRAK® CODE APPROVALS AND PERFORMANCE STANDARDS

ClarkDietrich® ProSTUD Drywall Framing System meets or exceeds these applicable performance standards.

### ProSTUD® Drywall Framing Standards

AISI S100-16 (2020) w/S2-20 - North American Specification for the Design of Cold-Formed Steel Structural Members

AISI S220 - North American Standard for Cold-Formed Steel Framing Nonstructural Members

Section A3 Material - Chemical & mechanical requirements (Referencing ASTM A1003/A1003M)

Section A4 Corrosion Protection (Referencing ASTM A653/A653M)

Section A5 Products - Thickness, shapes, tolerances, identification

Section C Installation (Referencing ASTM C754)

AISI S202 - Code of Standard Practice for Cold-Formed Steel Structural Framing

Section F3 Delivery, Handling and Storage of Materials

ClarkDietrich Nonstructural Framing comply with:

IBC-2021 - International Building Code

Intertek CCR-0207

LA RR #26019 - City of Los Angeles ProSTUD Research Report

NYC - OTCR ProSTUD Approval Letter

SFIA (Steel Framing Industry Association) Code Compliance Certification Program

UL 263 "Fire Tests of Building Construction and Materials"

ASTM E119 - Standard Test Methods for Fire Tests of Building Construction and Materials

ASTM E72 - Standard Test Methods of Conducting Strength Tests of Panels for Building Construction

ASTM E90 - Standard Test Method for Laboratory Measurement of Airborne Sound Transmission Loss of Building Partitions and Elements

Multiple UL® design listings for ProSTUD:

Over 50 UL Designs. See UL file number R26512 for additional information.

UL® and UL® Design are service marks of Underwriters Laboratories, Inc.

U.S. Patent No. 9,010,070

### LEED® Services

#### BUILD GREEN with ClarkDietrich

ClarkDietrich is an active member of the U.S. Green Building Council and is committed to supplying quality products that are environmentally responsible. We are continually working to develop greener building products and sustainable business practices. ClarkDietrich steel framing helps contribute points toward LEED® certification. For more details contact Technical Services at 888-437-3244 or visit [www.clarkdietrich.com/LEED](http://www.clarkdietrich.com/LEED).

ClarkDietrich has prepared this literature with the utmost diligence and care for accuracy and conformance to standards.

ClarkDietrich intends this information to be accurate, informative, and helpful as a selection guide for choosing ClarkDietrich products. However, this information is only to be used for guidance and is not intended to replace the design, drawings, specifications, and decisions of a professional architect or engineer.

ClarkDietrich or its affiliates shall not be responsible for incidental or consequential damages, directly or indirectly sustained, nor for loss caused by application of our products for other than their intended uses. Our liability is limited to replacement of defective products. Claims shall be deemed waived unless they are made to us in writing within thirty (30) days of the date a problem was or reasonably should have been discovered.

ClarkDietrich reserves the right to modify or change any information contained in this literature without notification.

ClarkDietrich is a proud member of the Steel Framing Industry Association (SFIA). Check the updated list of Certified Production Facilities at Intertek's website at [www.intertek.com](http://www.intertek.com). Additional code approvals SFIA (Steel Framing Industry Association) Intertek CCR0207.

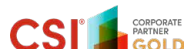

USGBC and related logo is a trademark owned by the U.S. Green Building Council and is used by permission.



For the most up to date version of all ClarkDietrich literature, scan the QR code.

## LOCATIONS

### ClarkDietrich Manufacturing and Sales Locations:

**CALIFORNIA** Riverside  
P 951.360.3500

**CALIFORNIA** Sacramento  
P 951.360.3500

**CONNECTICUT** Bristol  
P 866.921.0023

**FLORIDA** Dade City  
P 352.518.4400

**FLORIDA** Miami  
P 305.477.6464

**GEORGIA** McDonough  
P 678.304.5500

**ILLINOIS** Rochelle  
P 800.659.0745

**MARYLAND** Baltimore  
P 410.477.4000

**MISSOURI** O'Fallon  
P 636.300.1411

**OHIO** Warren - East  
P 330.372.5564

**OHIO** Vienna  
P 330.372.4014

**TEXAS** Dallas  
P 214.350.1716

**TEXAS** Pasadena  
P 281.383.1617

**CLIP EXPRESS™**  
P 866.638.1908

### ClarkDietrich Engineering Services. A full spectrum of solutions.

Toll-Free Phone: 877.832.3206

Toll-Free Fax: 877.832.3208

Technical Services: 888.437.3244

Email: [engineering@clarkdietrich.com](mailto:engineering@clarkdietrich.com)

**CENTRAL** Merrillville, IN  
**NORTHEAST** Bristol, CT

**SOUTHEAST** McDonough, GA  
**WEST** Carlsbad, CA

Turn to ClarkDietrich for a complete lineup of steel construction products and services nationwide:

Interior Framing · Exterior Framing · Interior Finishing · Exterior Finishing · Clips/Connectors · Engineering



9050 Centre Pointe Dr. Suite 400  
West Chester, OH 45069

P 513.870.1100  
F 513.870.1300

[clarkdietrich.com](http://clarkdietrich.com)  
Clarkwestern Dietrich Building Systems LLC